

Service Service Service

GranBaristo Avanti

GranBaristo



Service Manual

Rev. 02 July 2014

TECHNICAL INFORMATION

Power supply and output:	240 V~ 50 Hz 1900W - 230 V~ 50/60 Hz 1900 W 120 V~ 60 Hz 1300 W
Temperature monitoring:	(NTC) variable resistor sensor - transmits the value to the electronic card
Safety system:	2 thermostats at 190°C one shot
Coffee heat exchanger output: Stainless steel for coffee, hot water and steam dispensing	(230 V~) 1900 W - (120 V~) 1300 W - (100 V~) 1100 W
Dimensions: W x H x D in mm:	210 x 360 x 460 mm
Stand-by power consumption	< 0,5W
Weight:	13 kg
Water tank capacity:	1.7 l
Coffee bean hopper capacity:	270 g. of coffee beans
Dreg drawer capacity:	20
Heating time:	Approx. 45 sec.
Water circuit filling time:	Approx. 15 sec Max. on first filling cycle
Power consumption:	During heating phase- approx. 5.6 A
Automatic dosage:	Dose adjustment controlled by the electronic system

Material

Housing	ABS/ABS+PMMA/METAL
Beans container	ABS
Water tank	SAN
Dreg drawer	ABS

All parts of this document are the property of Saeco International Group.

All rights reserved. This document and all the information herein is provided without liability deriving from any errors or omissions. Furthermore, no part may be reproduced, used or collected, except where express authorisation has been provided in writing or through a contractual agreement.

Table of contents	Page	Table of contents	Page
1. Introduction		6. Standard checks	
1.1. Documentation required	1	6.1. Repair schedule	1
1.2. Tools and equipment required	1	6.2. Service schedule	1
1.3. Material	1	6.3. Final test	2
1.4. Safety warnings	1		
1.5. Service Policy	2	7. Disassembly	
1.6.1. External machine parts	3	7.1. Outer Shell	1
1.6.2. Internal machine parts	4	7.2. Service door	2
		7.3. Coffee grinder	3
2. Technical specifications		7.4. Grinder blades	3
2.1. Technical specifications	1	7.5. Coffee grinder adjustment	4
2.2.1. Specification for the measurement of the coffee products temperature	2	7.6. Solenoid valve and assembly drain valve	4
2.2.2. Specification for the measurement of the Milk products temperature.	3	7.7. The piston assembly	5
2.3. Machine parameters and performance	5	7.8. Pin boiler	5
2.4. How to Check for oil leakage in piston assembly.	6	7.9. Termostat	5
		7.10. Pump	6
3. User instructions		7.11. Flow-meter	6
3.1.1. Customer menu in the GranBaristo Avanti	1	7.12. Gearmotor and Microswtch present BrewUnit	6
3.1.2. Customer menu in the GranBaristo	4	7.13. CPU board and KYB interface and display	8
3.2. Operation, cleaning and maintenance	5	7.14. Bluetooth board in GranBaristo Avanti	9
		7.15. Fitting and removing Oetiker clamps	9
4. Operating logic		8. Notes	
4.1.1. Water circuit GranBaristo	1	9. Water circuit diagram	
4.1.2. Milk carafe	2	10. Electrical diagram	
4.2. Coffee cycle	3		
4.3. Single microswitch	4		
4.4. Temperature sensor	4		
4.5. Coffee grinder	5		
4.6. Water level detection (water tank)	5		
4.7. Descaling request	6		
4.8. Water filter	6		
5. Troubleshooting			
5.1.1. Test Mode in GranBaristo Avanti	1		
5.1.2. Test Mode in GranBaristo	8		
5.1.2. Disagnostic Mode in GranBaristo/GranBaristo Avanti	14		
5.2. Error codes	18		

MODIFICATIONS TO SERVICE MANUAL				
From Rev.	To Rev.	Chapter	Inserted	Modified
REV.00	REV.01	02	Par.2.4 How to check for oil leakage in piston assembly.	
		05		Par. 5.1.1. Test Mode Granbaristo
REV.01	REV.02	01		Par. 1.6.1. External machine parts
				Par. 1.6.2. Internal machine parts
		02		Par. 2.1. Technical specifications
		03	Par. 3.1.1 Customer menu in the GranBaristo Avanti	
		05	Par. 5.1.1. Test Mode in GranBaristo Avanti	
07	Par. 7.14 Bluetooth board in GranBaristo Avanti			



CHAPTER 1

INTRODUCTION

1.1 Documentation required

The following documentation is needed for repair procedures:

- Instruction booklet for specific model
- Technical documentation for specific model (diagrams, exploded view, symptom cure and service manual)

1.2 Tools and equipment required

As well as the standard equipment, the following is required:

Qty.	Description	Notes
1	Screwdriver	
1	Pliers for Oetiker clamps	
1	CC -A - Vdc tester	
1	Digital thermometer	Scale limit > 150°C
1	SSC (Saeco Service Center)	Programmer (for programming and diagnostics mode)

1.3 Material

Description	Notes
Thermal paste	Heating element > 200°C
Descaler	Saeco descaler
Grease solvent	Personal choice
Silicone grease	Safe to use with food

1.4 Safety warnings

We recommend you consult the technical manual of the machine before performing any maintenance work.

Observe all applicable standards relating to the repair of electrical appliances.

Always disconnect the power plug from the mains before beginning repair work.

Simply turning off the main machine power switch is not an adequate safety precaution.

This domestic appliance is rated as insulation class I.

On completion of the repair work, insulation and dielectric rigidity tests must be performed.

1.5 Service POLICY grid as used for coffee machine

For IN WARRANTY repairs is mandatory to use the single components (not the assembly) available in the exploded views of the coffee machines or of the specific components. If you find the information "SEE THE EXPLODED VIEW E....." in the assembly description field, it means that the single components of the assembly are available in the other pages of the exploded view. It's possible to use the assembly only if there is a specific Symptom Cure that include this possibility or when the single components are not available for the order.

List of principal assembly present in all our coffee machines

Components	Assembly use	Single components available
COFFEE GRINDER	<u>Only for OOW repairs</u>	YES , to consult the specific exploded-view of the machine or of the Coffee Grinder on website
BREWING UNIT	<u>Only for OOW repairs</u>	YES , to consult the specific exploded-view of the machine or of the Brewing unit on website
PISTON UNIT ASSY.	<u>Only for OOW repairs</u>	YES , to consult the specific exploded-view of the machine on website
GEAR MOTOR	<u>Only for OOW repairs</u>	YES , to consult the specific exploded-view of the machine on website
FILTER HOLDER	<u>Only for OOW repairs</u>	YES , to consult the specific exploded-view of the machine on website
MILK CARAFE	<u>Only for OOW repairs</u>	YES , to consult the specific exploded-view of the machine on website

1.6.1 External machine parts

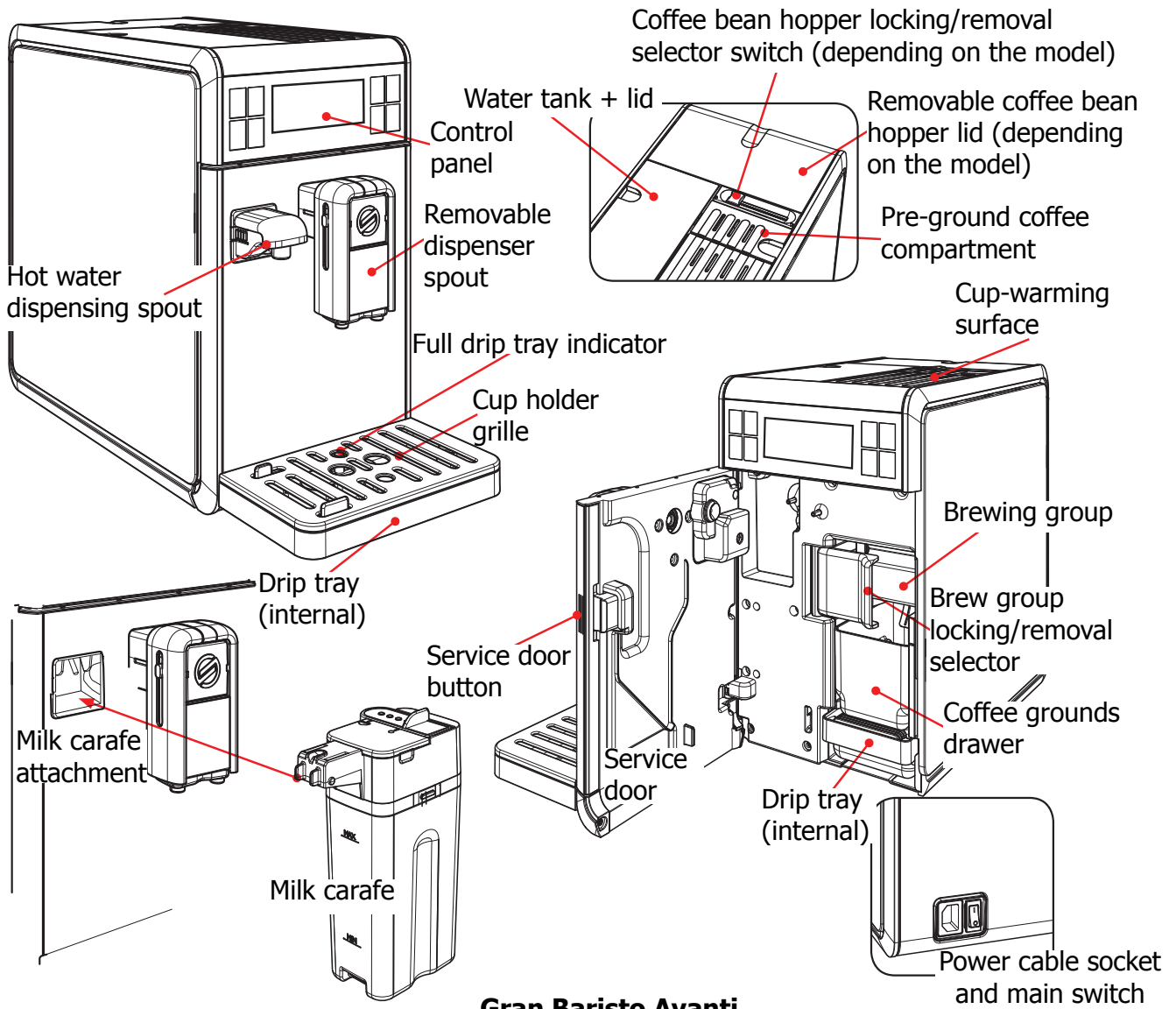

Gran Baristo Avanti

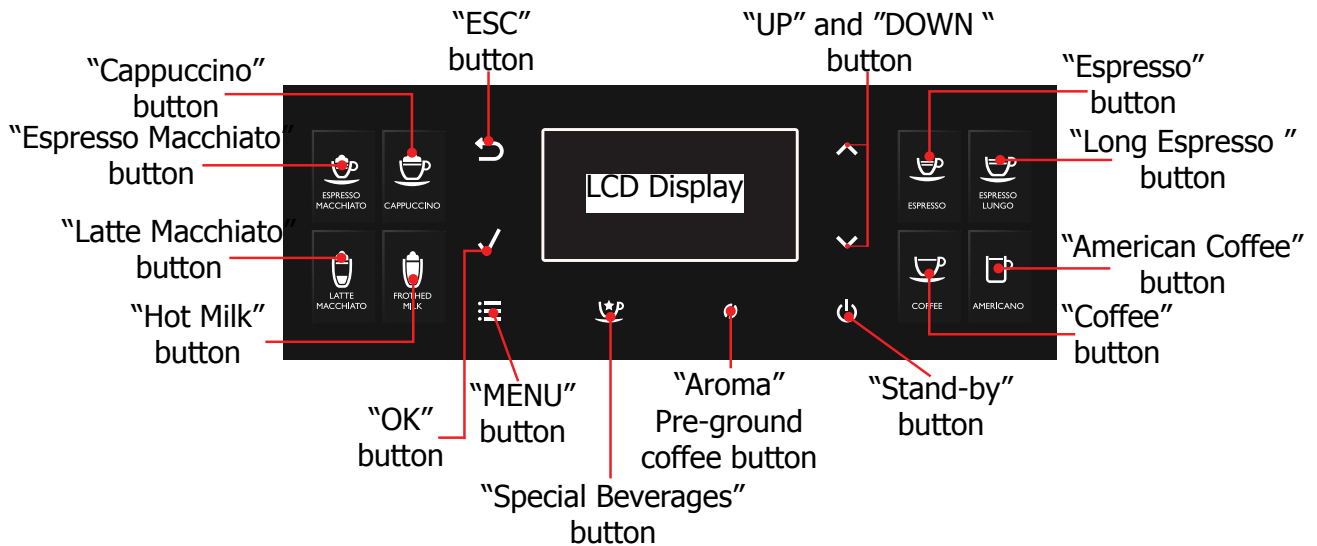

Gran Baristo

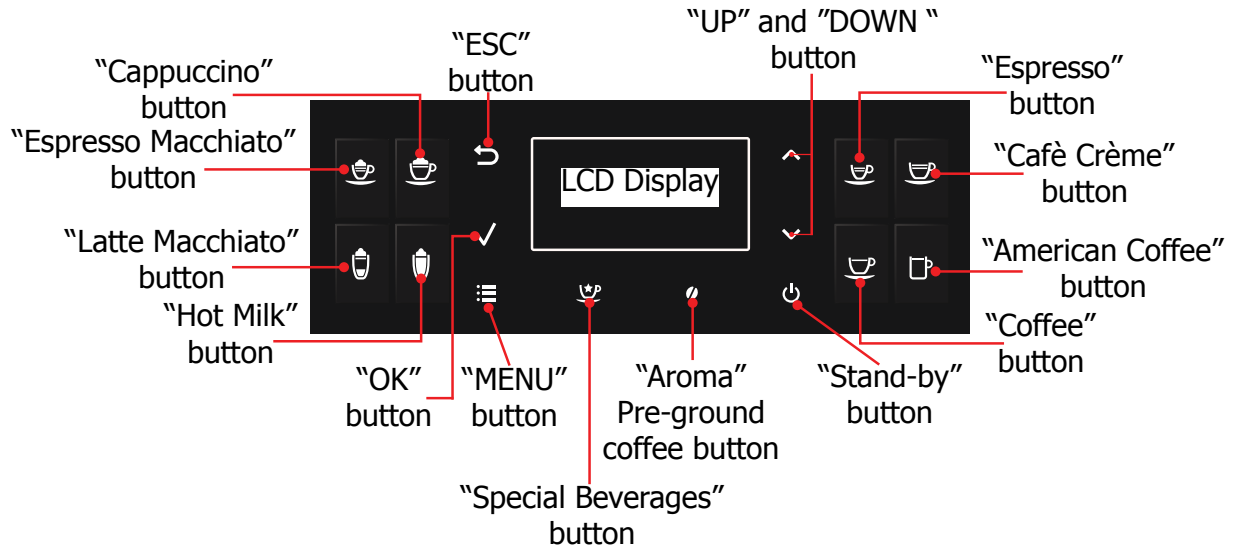

1.6.2 Internal machine parts

Grinding adjustment insert



Coffee grinder

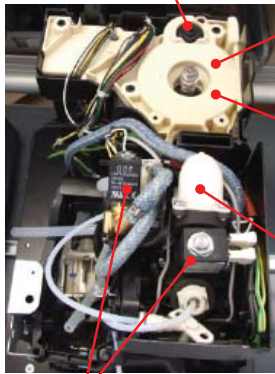

Cover and Coffee grinder

Piston assembly

Solenoid valve

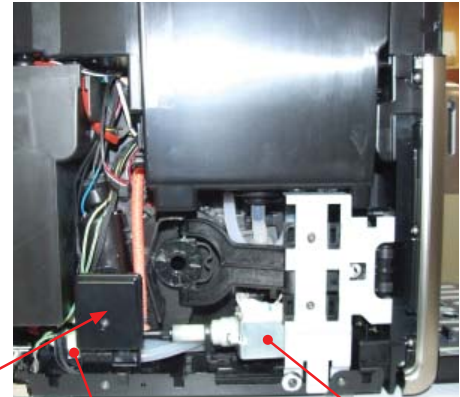

Flow-meter

Pump



Bluetooth board in Granbaristo Avanti



Power board

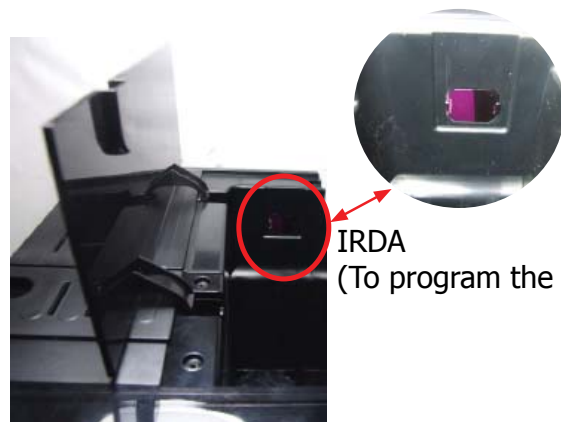

IRDA (To program the machine)



CHAPTER 2

TECHNICAL SPECIFICATIONS

2.1. Technical specifications

Power supply and output:	240 V~ 50 Hz 1900W - 230 V~ 50/60 Hz 1900 W 120 V~ 60 Hz 1300 W
Temperature monitoring:	(NTC) variable resistor sensor - transmits the value to the electronic card
Safety system:	2 thermostats at 190°C one shot
Coffee heat exchanger output: Stainless steel for coffee, hot water and steam dispensing	(230 V~) 1900 W - (120 V~) 1300 W - (100 V~) 1100 W
Gear motor:	2 rotation directions; power supply 24VC
Pump:	Ulka Type EP5/S GW approx. 13-15 bar with reciprocating piston and thermal switch 100°C 48 W, 230V, 50 Hz, 120V, 60Hz 100V, 50/60 Hz
Overpressure valve:	Opening at approx. 16-18 bar
Water filter:	In tank
Coffee grinder:	Direct current motor with flat ceramic grinder blades
Automatic dosage:	Dose adjustment controlled by the electronic system
Power consumption:	During heating phase- approx. 5.6 A
Dimensions: W x H x D in mm:	210 x 360 x 460 mm
Weight:	13 kg
Water tank capacity:	1.7 l
Coffee bean hopper capacity:	270 g. of coffee beans
Dreg drawer capacity:	20
Water circuit filling time:	Approx. 15 sec Max. on first filling cycle
Heating time:	Approx. 45 sec.
Grinding time:	Approx. 8-10 sec.
Only Gran Baristo Avanti	
Bluetooth:	Bluetooth Smart (low energy)
Maximum use distance:	5 m
Tablet compatibility:	Avanti App is compatible with iPad 3/4/Air/mini retina, running iOS7 and newer; with Samsung Galaxy Tab 3 (8.0")/Tab 4 (10.1")/Note pro LTE (12.2"), Nexus 7 2013 (7"), Sony Xperia Z LTE (10.1"), running Android v.4.3 and newer, and Bluetooth version 4.0 and newer.

2.2.1. Specification for the measurement of the coffee products temperature.

The temperature is influenced by the flow from the dispenser and stratification of temperatures in the glass. In order to consider these phenomena and to introduce measures that allow comparisons in controlled conditions, below guidelines must be followed:

Conditions:

- a) Water temperature in tank: 23°C (+/-2°C).
- b) It must be used a plastic cup (see picture N°1).
- c) It must be used a thermocouple thermometer (e.g. type K - see picture N°2).
- d) The coffee machine is tested without any change of parameters or calibrations, which may affect the temperature of products, so the measurement of temperature must be done with machine in default factory setting.

Procedure:

1. The temperature must be measured in the cup, immediately after dispensing. Cup has to be placed on a non-metal surface using a thermocouple thermometer.
2. The temperature in the cup is measured by immersing the probe of the thermometer up to touch the bottom. The probe then must be moved in a circular motion for 5/6 rotations. At the end of the rotations, stop in the center of the cup.
3. The highest temperature measured during the rotations is the value we are searching for, and that must be reported;
4. Test measurement: from end of dispensing to the end of rotations must be completed within 12 seconds.

Limits of acceptability

The acceptance limits are divided by features and products and are the following:

Espresso Coffee Italy Q.ty 25/40 gr.

Temperature of 1st product 69°C ≤ 85°C

Temperature of 2nd product 72°C ≤ 85°C

Coffee Q.ty 70/120 gr.

Temperature of 1st product 69°C ≤ 85°C

Temperature of 2nd product 72°C ≤ 85°C



2.2.2. Specification for the measurement of the Milk products temperature.

Milk evaluation

To carry out the test, a partially skimmed UHT milk with a percentage of grease between 1.5-1.8% at a refrigerator temperature $T_{refr.}$ (between 4 to 10°C) must be used.

The milk product must be checked on a beaker of 250 ml of capability and with an inner diameter of 70mm, brewing 100gr of product.

Parameters to be respected:

The parameters to be respected are: milk temperature and height of the cream. Each of these parameters, however, must be evaluated depending on the type of system used for the production of hot milk.

Actually three types of devices are present on the appliances:

- Manual system (pannarello)
- Semi-Automatic system (cappuccinatore)
- Automatic system (carafe, Pinless wonder system, etc.)

Milk temperature in the beaker:

System without Pinless Wonder: e.g. Xelsis, Exprelia, Syntia, Intelia.

With milk at $T_{refr.}$ (about 4-10 °C): $\Delta \geq 36$

System with Pinless Wonder: New royal, Energica Pure, Intelia EVO Latte.

With milk at $T_{refr.}$ (about 4-10 °C): $\Delta \geq 45$

Height of the milk cream in the beaker:

Manual system (pannarello)

≥ 15 mm on 100gr. of brewed product

Semi-automatic system (cappuccinatore)

≥ 20 mm on 100gr. of brewed product

Automatic system: carafe, cappuccinatore, Pinless wonder (New Royal, Energica Pure, Intelia EVO latte)

≥ 20 mm on 100gr. of brewed product

How to measure the temperature of the milk.

- 1) The measurement is carried out in the beaker, immediately after the end of milk brew, positioned on a non-metallic surface, using a thermocouple thermometer (eg. Type K). Stop the preparation of mixed product: at the end of milk brewing, where "One Touch product" function is present.
- 2) The temperature is measured by immersing the probe of the thermometer, positioning the probe inside the beaker at about 10mm from the bottom of the container, then the probe moves in a circular motion for 3-5 turns, stopping at the end, at the center of the beaker. It detects the maximum temperature reached in a time of relief between 3 to 5 seconds. It is important the mixing of milk before the measurement at 10mm from the bottom of the beaker. If the mixing is correct, temperature, for a few fractions of a second, during the measurement should not oscillate.

How to measure the milk cream.

The temperature (Trefr or Tamb) of the milk doesn't affect as much the test result on measuring the milk cream; by convection is assumed to always use milk at refrigerator temperature Trefr.

Manual systems (Pannarello)

Pour 100cc. of milk at Trefr. in a beaker of 250 ml of capacity and with a inner diameter of 70 mm; with machine in steam mode:

1. Open the steam knob to discharger water circuit for 4 sec, then close the knob.
2. Place the beaker with the frother dipped in milk, open the steam knob to maximum and start the chronometer.
3. After about 30 to 60 seconds, close the knob and check the result on milk.

Semi-automatic systems (cappuccino)

Pours milk at Trefr. in a container ; with the machine in steam mode:

1. Open the steam knob to discharge water circuit for 4 sec. then close the knob.
2. Insert the silicone tube in the milk container, placing a beaker of 250 ml capacity and with an inner diameter of 70 mm under the cappuccino maker and open the steam knob.
3. After having provided 100gr. of product, close the knob and check the result obtained on milk. Note: The same applies to machines which have a steam key on the user interface and a solenoid valve in place of the steam tap.

Automatic: Carafe, Cappuccino Pinless wonder (New Royal, Energica Pure, Intelia EVO Latte), etc..

After setting the machine to delivery of 100gr. of product:

1. Launch the "hot milk" function.
2. Collect the product in a beaker with a 250ml of capacity and with an inner diameter of 70 mm, and verify the result obtained on milk. Carry out the test using milk at a Trefr..

In case the machine allows modify of the emulsion through the menu, use the machine with the emulsion set to the default value.

Related to the above testing procedure derives the following table of acceptability:

Manual, Semi-Automatic and Automatic's Milk System	
Grams of Product	Minimun Height of the milk cream
≥ 130	≥ 30mm
120	≥ 25mm
110	≥ 22mm
100	≥ 20mm
90	≥ 16mm
80	≥ 13mm
70	≥ 11mm

NB: To verify more accurately the height of the cream, a practical expedient dictated by experience is to add to the product just delivered a small amount of coffee. The addition of coffee immediately put in evidence the surface of separation between liquid and cream.

2.3. Machine parameters and performance

PRODUCT QUANTITY	Minimum Water quantity (ml)	Maximum Water quantity (ml)	Default Water quantity (ITA) (ml)	Default Water quantity (ENG) (ml)	Milk Length (sec)	Aroma
AmericanCoffee	110	320	170	170		3 = Regular
Espresso	30	70	40	50		3 = Regular
Cafe Creme	40	110	70	70		3 = Regular
Coffee	70	140	110	110		3 = Regular
Ristretto	20	40	30	30		3 = Regular
Espresso Mild	30	70	40	50		2 = Mild
Espresso Intenso	40	110	70	70		6 = Extra Strog
Energy Coffee	110	320	170	170		6 = Extra Strog
Hot Water	50	450	300	300		
Latte Macchiato	30	170	70	110	Default: 25 Range: 10-75	3 = Regular
Cappuccino	30	170	40	70	Default: 20 Range: 10-50	3 = Regular
Espresso Macchiato	30	70	40	50	Default: 5 Range: 5-30	3 = Regular
Cafe au lait	30	260	70	110	Default: 20 Range: 10-50	3 = Regular
Frothed Milk					Default: 30 Range: 10-75	
Startup Rinsing			100	100		
Short Rinsing			40	40		
Power off Rinsing			100	100		
Water filter activation			1000	1000		
Brewing Unit cleaning			800	800		

Descaling cycle frequency			
Hardness	Water hardness	Without water filter	With water filter
1	Soft (up to 7°dH)	240 litres (480,000 pulses)	480 litres (960,000 pulses)
2	Medium (7° - 14°dH)	120 litres (240,000 pulses)	240 litres (480,000 pulses)
3	Hard (15° - 21°dH)	60 litres (120,000 pulses)	120 litres (240,000 pulses)
4	Very hard (over 21°dH)	30 litres (60,000 pulses)	60 litres (120,000 pulses)

The default water hardness level is 4. Each litre of water corresponds to approximately 2,000 pulses.

In the machines where is not possible change the water hardness the default hardness level is 3.

2.4. How to Check for oil leakage in piston assembly.

In case of return because the machine indicates no coffee one of the causes could be the loss of oil from the piston assembly. To check this, proceed as follows:

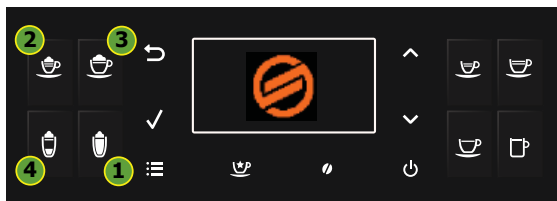

To enter Test Mode
When the display is turning ON, press the keyboard buttons in the order described below:

Press **UP** (^): go to next page

Brew Unit

This page allows to test the functionality of Brew Unit, BU Encoder, frontal door and dreg drawer:

BREW		UNIT	
Work	Home	mA: 0	
0	Ev Oil	Rst	4000
DDr	H/W	Door	Pres

The meaning of the sectors are the following:

Command:

Work: when pressed moves the brew unit to WORK

Home: when pressed moves the brew unit to HOME

Ev Oil: when pressed activates/deactivates the Oil electrovalve (24V Dc)

Rst: when pressed moves the brew unit in RESET(extraction) position(stop the brew unit if was in movement)

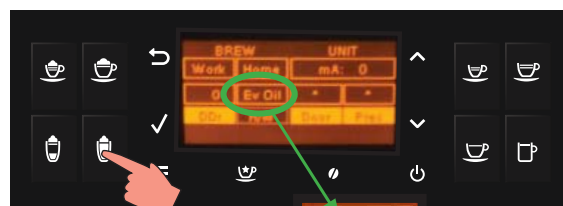

EV deactivate

The piston moves upward of approx. 5mm **(OK)**

ERROR: excursion >5mm approx. is **(KO)**

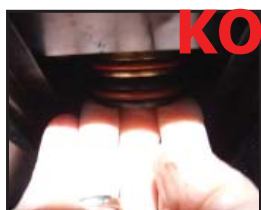
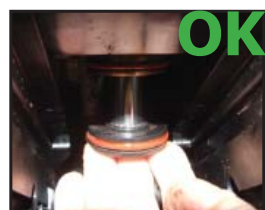

The piston moves up in case of lack of oil



EV activate

The piston moves upward until it stops.

WARNING: Deactivate the EV only when it goes back into its original position. Failing to do so could result in air being sucked into the circuit.



In case of oil leakage, remove the piston assembly clean any oil residue with a dry cloth and replace the piston assembly with a new one.

NOTE: Oil is of vegetal origin, certified for food contact, H3 (maximum in terms of food safety for oils).



CHAPTER 3

USER INSTRUCTIONS

3.1.1. Customer menu in the Gran Baristo Avanti

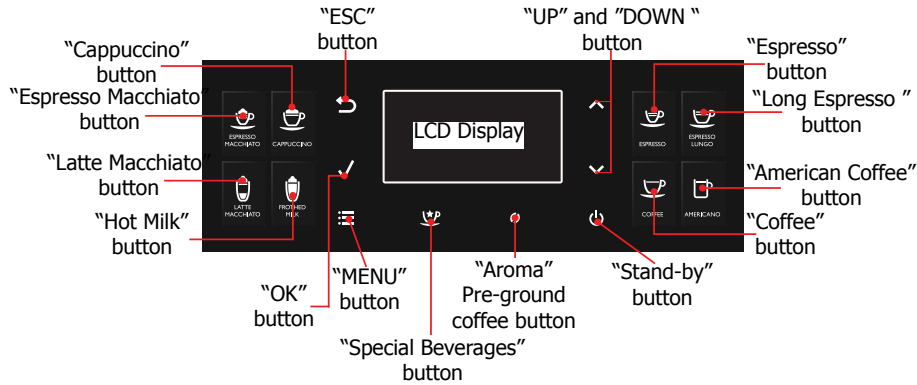

Display messages



Fill the coffee bean hopper.

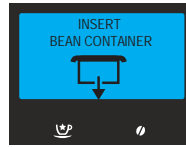

Insert the coffee bean hopper and/or beans lid.

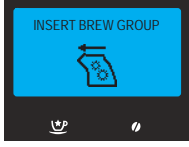

The brew group must be inserted into the machine.



Insert the coffee bean hopper lid and/or beans lid.



Insert the coffee grounds drawer and the internal drip tray.

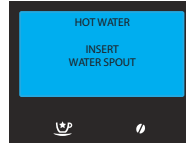

Insert the water dispensing spout to start dispensing. Press "ESC" to exit.

Empty the coffee grounds drawer.

Note: The coffee grounds drawer must be emptied only when the machine requires it and with the machine on. If the drawer is emptied with the machine turned off, the machine will not record the emptying operation.

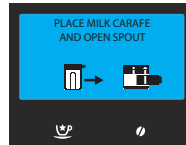
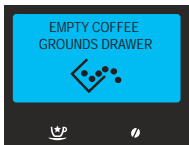

Before dispensing, insert the milk carafe with the dispensing spout open.



Close the service door.

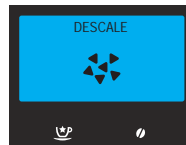

You need to descale the machine. Follow the steps described in the "Descaling" chapter of this manual. Please note that not descaling your machine will ultimately make it stop working properly. In this case repair is NOT covered under your warranty.



Remove the water tank and fill it. You can fill the water tank also through the dedicated hole on the lid.

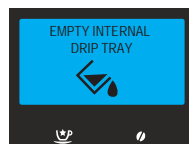

Open the service door and empty the internal drip tray. **Note:** If this operation is performed when the machine is on, it will record the coffee grounds drawer emptying and will reset the counter; therefore, you need to empty the coffee grounds as well.



The machine needs the "INTENZA+" water filter to be replaced.



The red light flashes. Press any button to exit the stand-by mode.

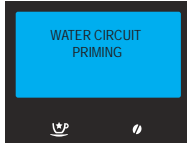

The machine is priming the water circuit. Wait for this operation to be over.

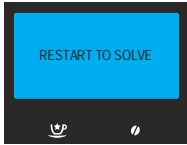

Take note of the code (E xx) shown on the display at the bottom. Turn off the machine. Turn it back on after 30 seconds. Repeat the procedure 2 or 3 times.

If the machine does not start, contact the Philips SAECO hotline in your country and quote the code shown on the display. Contact details can be found in the warranty booklet packed separately or at www.philips.com/support.

BLUETOOTH CONNECTION

Download the application on your mobile device to access the machine functions. To connect GranBaristo Avanti with your mobile device, download the Saeco Avanti App available on the App Store and Google Play or scan the QR code on the cover with your mobile device. As an alternative, connect to the www.saeco.com/Avanti-app website using the device on which you wish to download the application.



Note:

Before starting the connection procedure, make sure that the Bluetooth function on your mobile device is active.

The GranBaristo Avanti Bluetooth function is enabled by default. If it is disabled, follow the instructions below to enable it again:



Press the "☰" button to access the machine main menu.

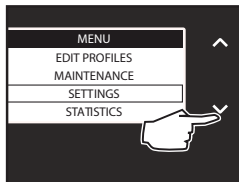

Press the "▼" button to select "SETTINGS". Press "✓" to confirm.

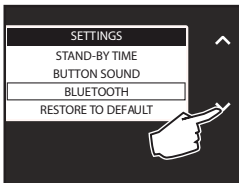

Press the "▼" button to select "BLUETOOTH".

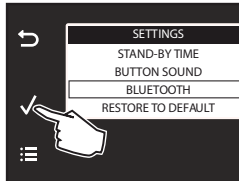

Press "✓" to confirm.

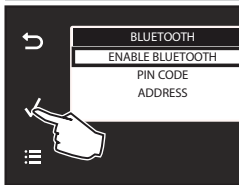

The "**BLUETOOTH**" management menu is displayed. Press "✓" to enable the function in the machine and to allow the connection of your mobile device.

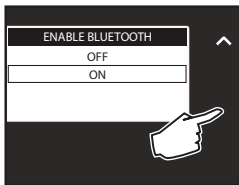

Press the "✓" button to select "**ON**".

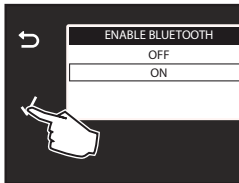

Press "✓" to confirm. The Bluetooth device is now active.

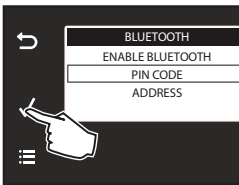

Press the "✓" button to select "**PIN CODE**". Press "✓" to confirm.

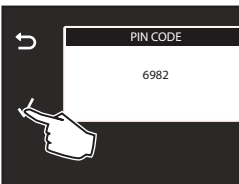

Write down the code, as it will be requested when connecting with your mobile device.

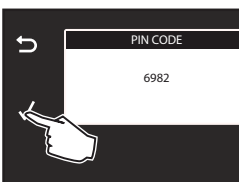

Press "✓" to confirm. Press the "☰" button to exit.

Note:
To exit the menu, press the "↶" button.



Enter the PIN code when you are prompted by the application and wait for a successful connection.

The  icon shown on the display indicates that the connection was successfully established. Now you can interact with your coffee machine directly from your mobile device.

Warning:

Use the Saeco Avanti app to control your Gran Baristo only when you can see the machine in order to avoid injury or damage! You cannot use the pre-ground coffee function when operating the machine via the app.

Caution:

If you enter the wrong PIN code 5 times in a row, the machine disables the Bluetooth connection for safety reasons. Therefore, you will need to enable it again as previously explained.

Note:

Avanti App is compatible with iPad 3/4/Air/mini retina, running iOS7 and newer; with Samsung Galaxy Tab 3 (8.0")/Tab 4 (10.1")/Note pro LTE (12.2"), Nexus 7 2013 (7"), Sony Xperia Z LTE (10.1"), running Android v.4.3 and newer, and Bluetooth version 4.0 and newer.

3.1.2. Customer menu in the Gran Baristo.

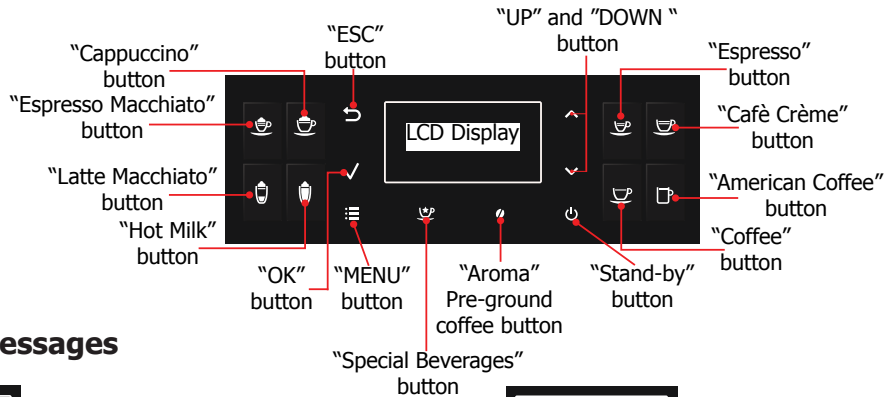

Display messages

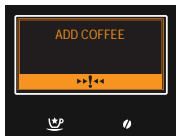

Fill the coffee bean hopper.

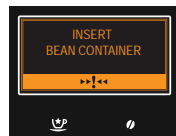

Insert the coffee bean hopper and/or beans lid.

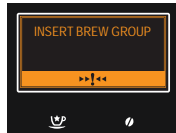

The brew group must be inserted into the machine.

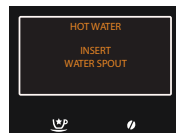

Insert the water dispensing spout to start dispensing. Press "ESC" to exit.

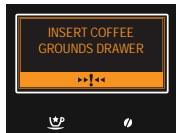

Insert the coffee grounds drawer and the internal drip tray.

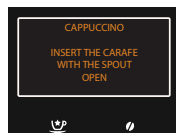

Before beginning to dispense, insert the milk carafe with the dispensing spout open.

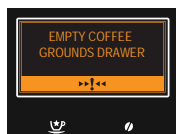

Empty the coffee grounds drawer.
Note: The coffee grounds drawer must be emptied only when the machine requires it and with the machine on. If the drawer is emptied with the machine turned off, the machine will not record the emptying operation.



The machine needs to be descaled. Follow the steps described in the "Descaling" chapter of this manual. Please note that not descaling your machine will ultimately make it stop working properly. In this case repair is NOT covered under your warranty.

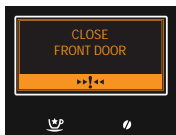

Close the service door.



The machine needs the "INTENZA+" water filter to be replaced.



Remove the water tank and fill it. You can fill the water tank also through the dedicated hole on the lid.



The red light flashes. Press any button to exit the stand-by mode.



Take note of the code (E xx) shown on the display at the bottom and check out the table "Error codes" (par.05 TROUBLESHOOTING) the type of error that occurred.

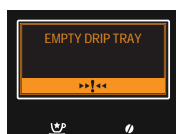

Open the service door and empty the internal drip tray.
Note: If this operation is performed when the machine is on, it will record the coffee grounds drawer emptying and will reset the counter; therefore, it is necessary to empty the coffee grounds as well.

3.2. Operation, cleaning and maintenance

Operating the machine		
1	Fill water tank	
2	Fill the coffee bean hopper	
3	Switch on the appliance	
4	Press the button to start the appliance	
5	Heating	When the heating phase begins, wait for it to finish
6	Rinse	Carry out a rinse cycle for the internal circuits
7	Machine ready	The machine is ready to dispense beverages

CLEANING AND TECHNICAL SERVICING		
A	Empty the dregs drawer	When indicated
B	Empty the drip tray	As necessary
C	Clean the water tank	Weekly
D	Clean the coffee bean hopper	As necessary
E	Clean the casing	As necessary
F	Clean the brewing unit	Every time the coffee bean hopper is filled or weekly
	Lubricate the brewing unit	After 500 dispensing cycles or when the grease is no longer present on the brewing unit
	Clean the unit housing	Weekly
H	Descaling	When indicated



CHAPTER 4

OPERATING LOGIC

4.1.1. Water circuit Granbaristo

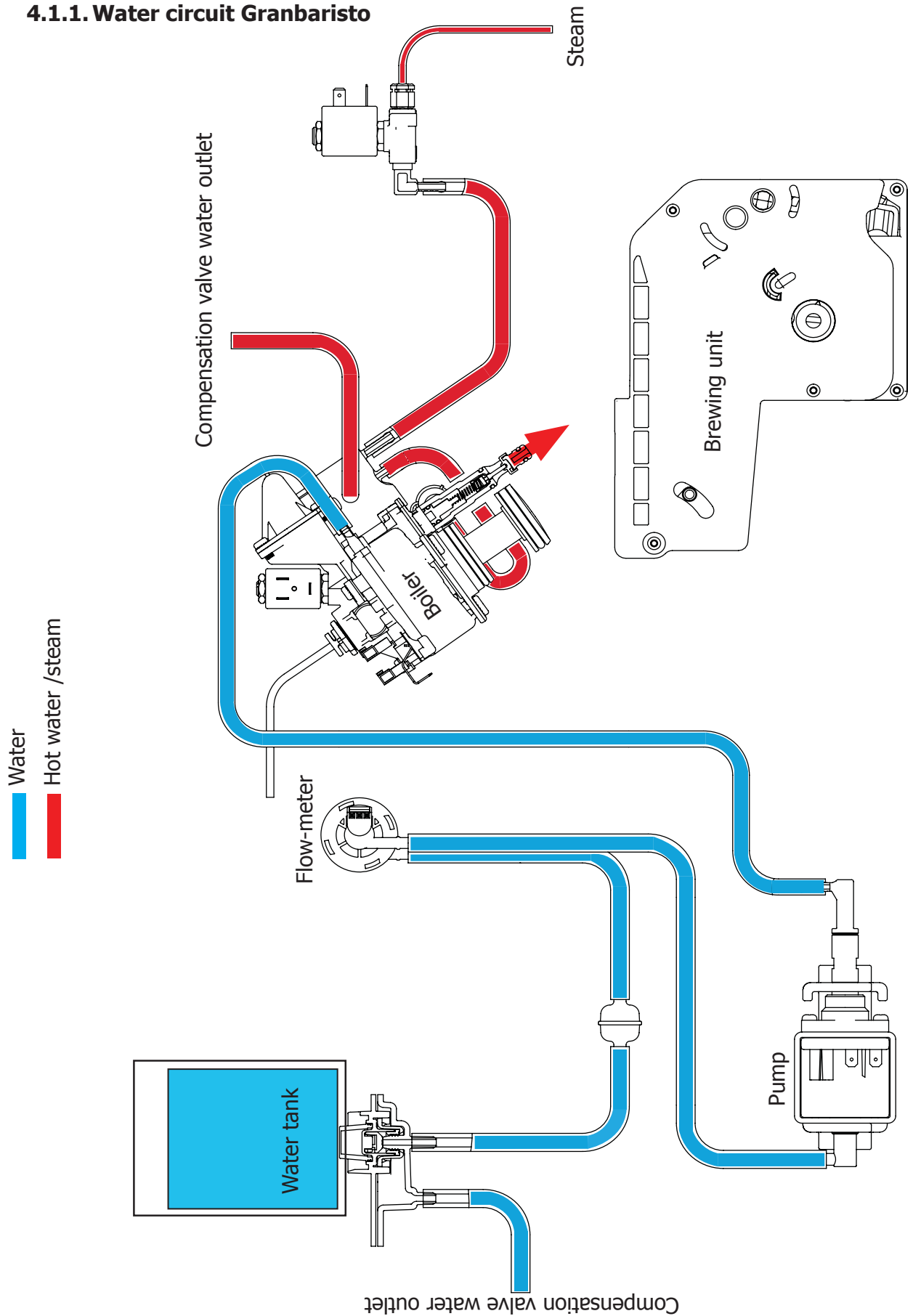

Compensation valve water outlet

4.1.2. Milk Carafe

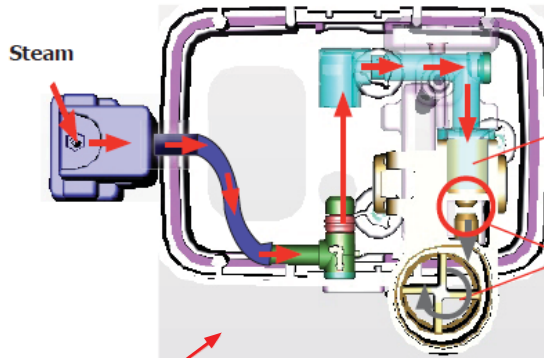

The steam passes through the pipe creating a sucking effect that pulls the milk upwards

The milk is heated by the steam and taken towards the emulsion chamber where it is mixed with air and transformed into foam

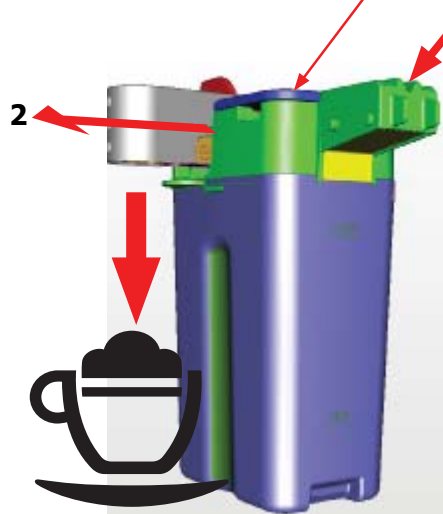

- 1) Steam input
- 2) Bring the cappuccino maker into dispensing position
- 3) Milk tank

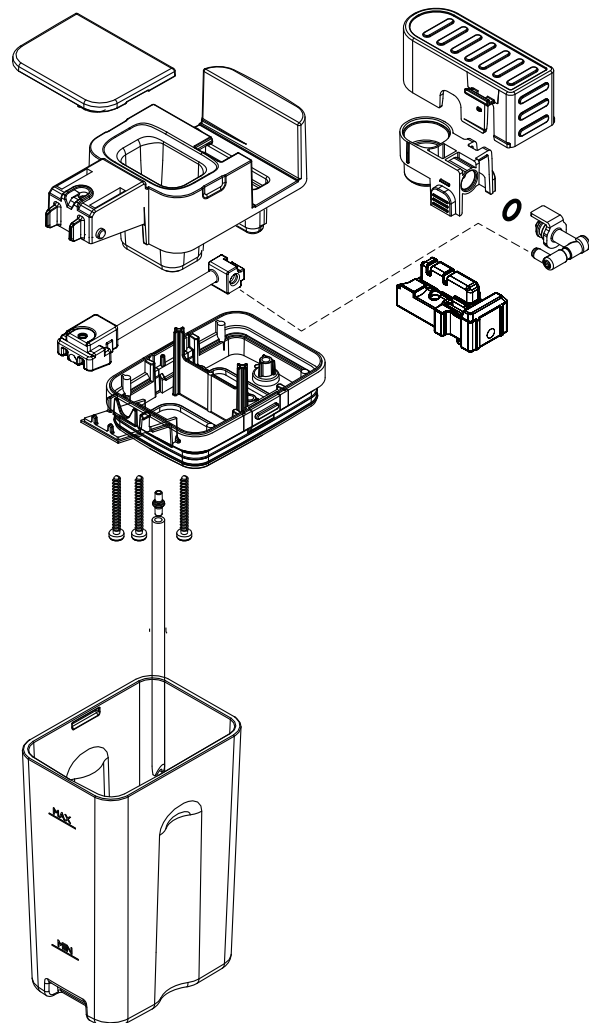

4.2. Coffee cycle

Main switch ON	START		STOP
Time			
Coffee grinder			Pulses (Dosage)
Heating	approx. 45 sec.		
Pump			Pump operation (flow meter pulses) in accordance with the amount of product selected.
Brewing unit gear motor			*
Status	Heating	Ready	Coffee cycle

Notes: * Only with Pre-brewing



Single microswitch gear motor

Switching on

When the machine is switched on, the gear motor repositions itself as follows:

- It acts on microswitch 1 (see following chapter).
- The gear motor changes its rotation direction and moves upwards again by approx. 1-2 mm.
- The boiler begins to heat the water for approx. 30 sec with controlled power, in order to reach the optimal temperature. The temperature will then remain at a constant level.

Coffee cycle

1. The grinding process is controlled by time duration in function of coffee strength selected.
2. The gear motor (brewing unit) moves to the brewing position.
3. Preliminary dispensing phase (short pump activity, short pause).
4. Product dispensing (the pump operation period is defined by the amount of product dispensed).
5. The gear motor moves to its home position (the dregs are expelled automatically).

4.3. Single microswitch

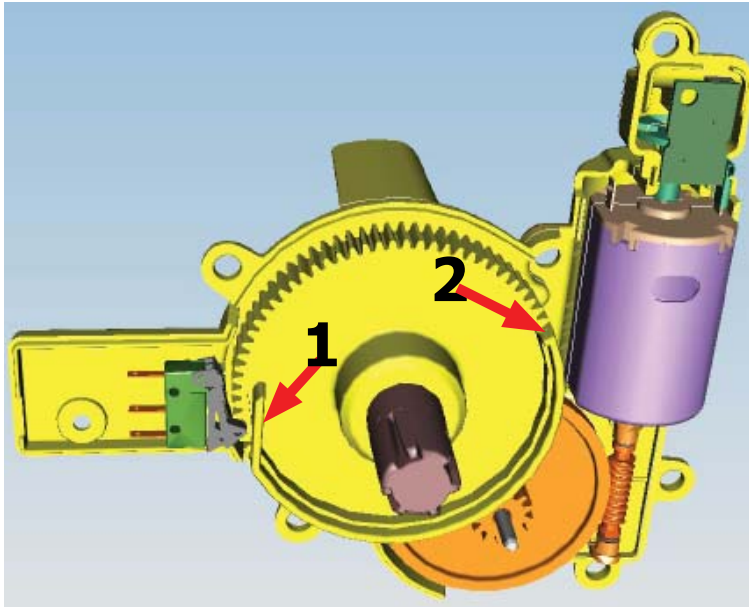

The gear motor is powered by a direct current motor that engages with the smaller double toothed wheel using a worm screw. The unit is mounted on the axle of the large gear wheel and when a coffee is requested, it moves from the standby position to the dispensing position, and then back to the standby position again.

- Standby position: 1

- Dispensing position: 2

4.4. Temperature sensor (adjustment)

Temp. (°C)	R nom (kΩ)	ΔR (+/- %)
20	61.465	8.6
50	17.599	5.9
75	7.214	4.1
80	6.121	3.7
85	5.213	3.4
90	4.459	3.1
100	3.3	2.5
125	1.653	3.9
150	0.893	5.1

An NTC is used as a temperature sensor; in the event of overheating this reduces boiler element power consumption.

The electronic system detects the current boiler temperature from the drop in voltage of the sensor and adjusts it accordingly.

Heating element values and corresponding temperatures: see table.

4.5. Coffee grinder

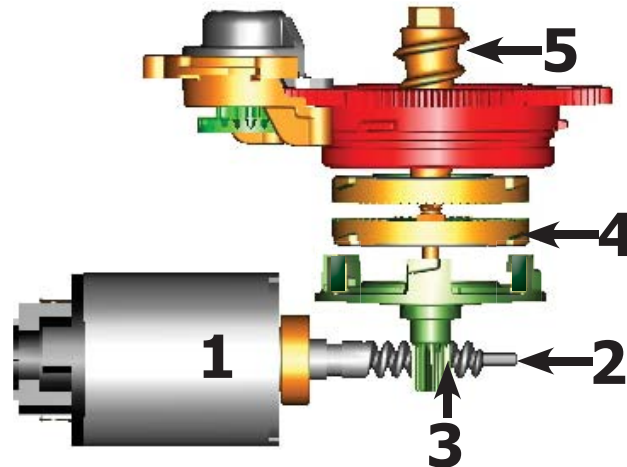

The coffee grinder is driven by a direct current motor (1) using a worm screw helicoidal wheel transmission (2).

The worm screw (2) drives a plastic gear wheel (3), which turns the lower grinder (4) and the increment pin (5)

4.6. Water level detection (water tank)

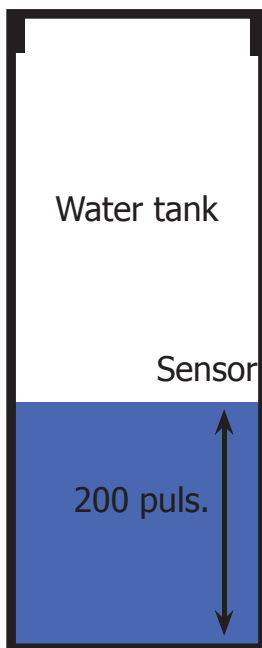

“Water low” message (water reserve)

Function:

The water level is monitored by a capacitive sensor, located one third of the way up the water tank wall.

If the electronics assembly detects, by means of the sensor, that the amount of water in the tank has dropped below the above mentioned level, a water reserve remains available for the dispensing process underway (this will cover 200 flow meter pulses).

The product dispensing process will then come to an end.

If a dispensing cycle ends after the sensor has been triggered (in the reserve) then the display “Water low” continues to be displayed during the following dispensing cycle.

4.7. Descaling request

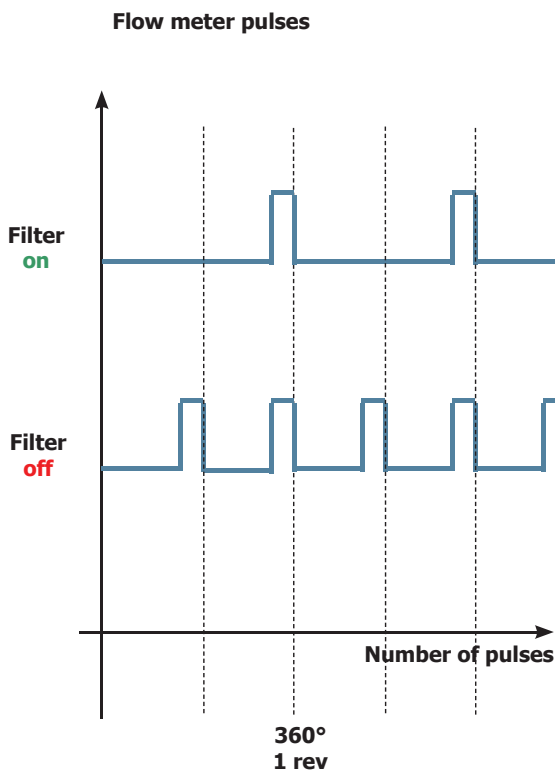

“Descaling” – message with water filter inserted

(appliances with display only)

The water hardness is set on the basis of the regional water hardness analysis (1, 2, 3, 4).

Filter off:

If the function is turned off the electronics assembly monitors the flow meter pulses, recording one pulse each turn.

Filter on:

If the function is turned on the electronics assembly monitors the flow meter pulses, recording one pulse every two turns.

“Change water filter” message

The electronics assembly uses the flow meter impulses to keep track of the amount of water which has flowed through; after the specified amount (set in accordance with the water hardness level), the “Replace filter” message appears.

4.8. Water filter

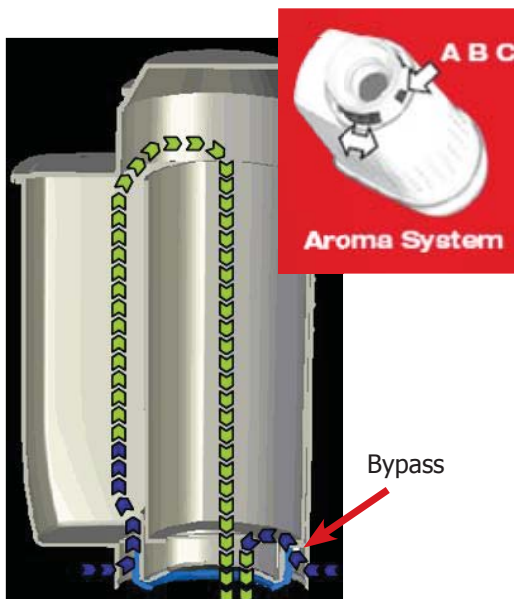

Function:

- Reduced limescale deposits which take longer to form.
- Improved water quality.
- Improved taste due to the ideal water hardness.

Life span / descaling performance:

- - 10 ° dH
- 60 litres
- 2 months

To achieve the best possible operating mode consistency over the total life span, the water is channelled using a 3-stage bypass (A, B, C) depending on the degree of hardness. See small image.



CHAPTER 5

TROUBLESHOOTING

5.1.1. Test Mode Gran Baristo Avanti

To enter Test Mode

When the display turns ON, press the keyboard buttons in the order described below:

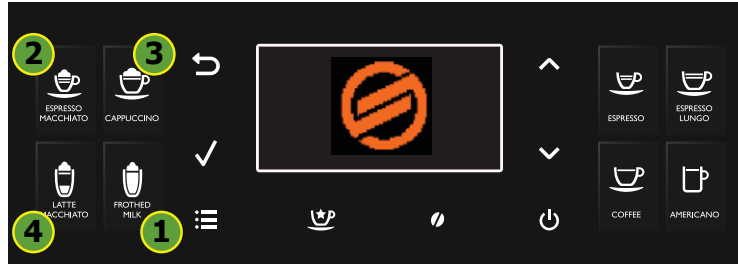

Description

When the machine is in Factory Test Mode appears a windows divided in several sectors:

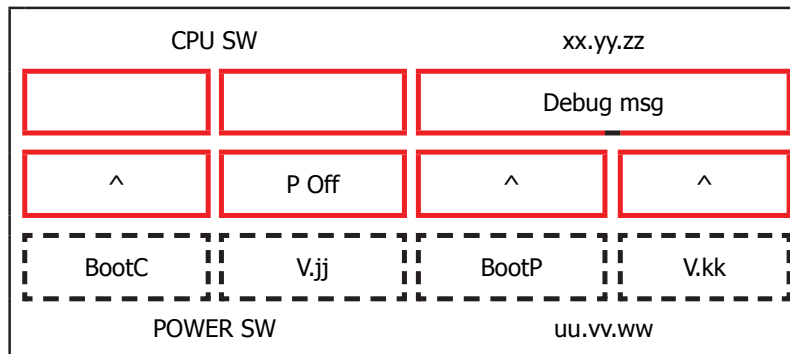

The first row of each window is a title, the red sectors represents the functions (or loads) available to activate or deactivate, the last row is used to show other info. When a function is enabled the corresponding box becomes colored. The dotted sectors is used to show informations about the status of microswitch, sensors or other variables.

The presence of symbol (^) into a sector indicate that no function is associated to.

The following image show the corrispondence between the keyboard and red sectors:

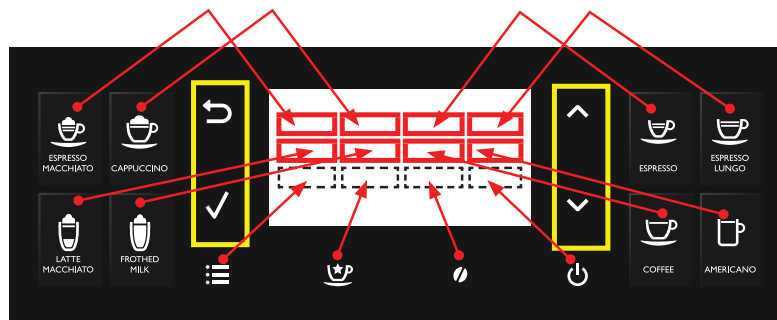

The keyboard buttons (ESC, OK, UP and DOWN), highlighted in yellow, have the following functions:

- UP** : go to next page
- DOWN** : go to previous page
- OK** (✓): confirm / enable / disable function
- ESC** (↵) : exit from Factory Test Mode

Activation of loads

In Test Mode all loads are initially disabled.

To activate a load press the corresponding button on keyboard, to deactivate press again the same button.

Other conditions for which a load may be switched off automatically without key presses are:

- If it is defined a working cycle, when this cycle ends (such as the grinder or brew unit)
- The achievement of 90°C for boiler

Navigation in Test Mode

SoftwareVersion

This is the first window of Factory Test Mode. It show the version of CPU software and CPU bootloader version, the PWR software and PWR bootloader version and is possible to activate or deactivate the POff feature and Debug info.

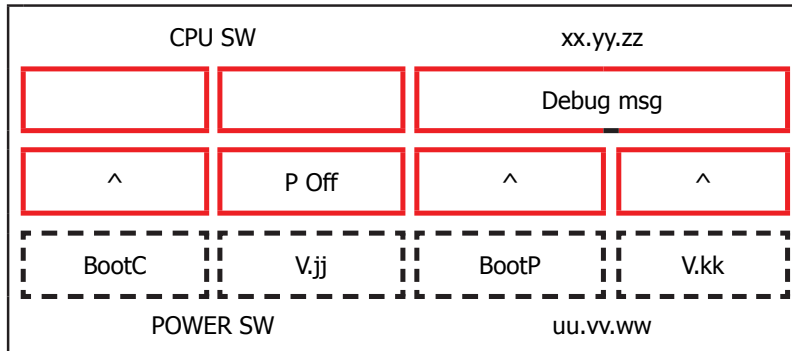

Press **OK (✓)** button to modify one of the following feature:

Debug msg: if enabled (colored box), only for next startup, allows the visualization of the following debug info on display in Ready state:

Grinder Time Aroma 1 (msec)	Encoder Pulses Home Work About Last Cycle	Encoder Dreg Counter: 4000 ->dreg drawer empty 0-> dreg drawer full	Grinder Time Aroma 4 (msec)
Grinder Time Aroma 2 (msec)			Grinder Time Aroma 5 (msec)
Grinder Time Aroma 3 (msec)			Grinder Time Aroma 6 (msec)
	Encoder Pulses from HOME to Pod Pressure about Last Cycle	Target Encoder Pulses from HOME to Pod Pressure about last Cycle	

P Off: if enabled (colored box), allows the machine to enter in standby mode immediately after powering ON from the main switch.

Make sure that the function **P Off** is turned ON and the **Debug msg** is turned OFF.

Press **UP (∧)**: go to next page

Keyboard

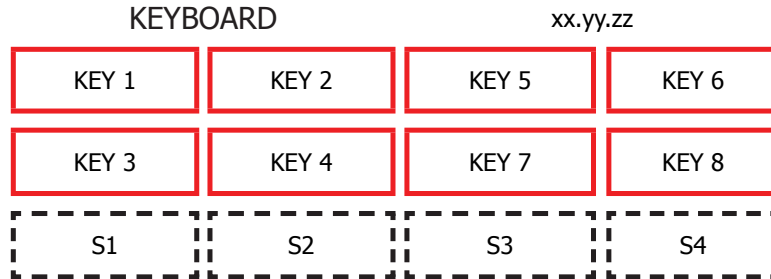

This page allow to test each button of keyboard (is shown its version) with the following correspondence:

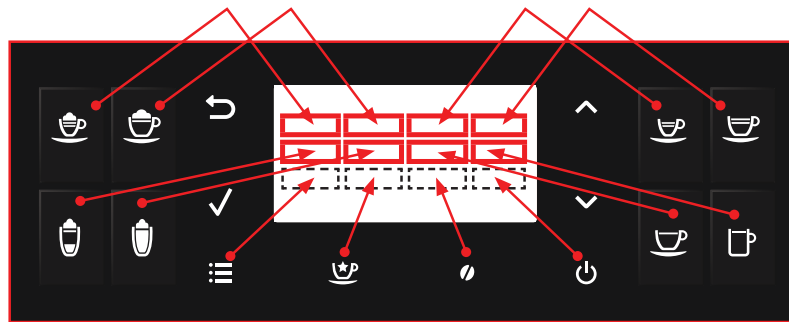

When is pressed a button the corresponding box becomes with background colored and the led of keyboard is turned ON, if it is pressed again becomes with black background and the led of keyboard is turned OFF(except for UP, DOWN and ESC that are always turned ON).

Press **UP** (^): go to next page

Brew Unit

This page allow to test the functionality of Brew Unit, BU Encoder, frontal door and dreg drawer:

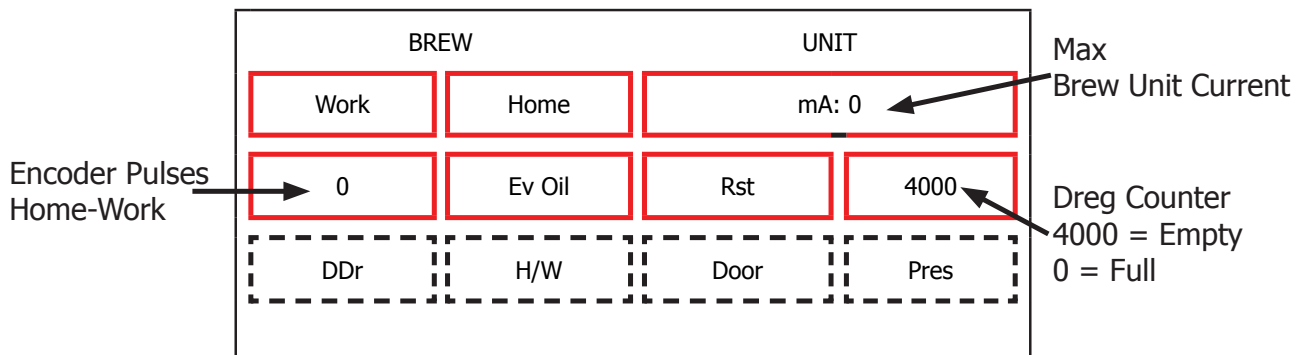

The meaning of the sectors are the following:

Command:

Work: when pressed move the brew unit to WORK

Home: when pressed move the brew unit to HOME

Ev Oil: when pressed activate/deactivate the Oil electrovalve (24V Dc)

Rst: when pressed move the brew unit in RESET(extraction) position(stop the brew unit if was in movement)

Info:

mA: indicates the maximum current (in mA) absorbed by the brew unit in motion. The value must not exceed 300 mA

Encoder Pulses Home-Work: indicate the number of encoder pulses from Home to Work position or vice versa. Move the brew unit from Home to work or vice versa and the measured value must be in the range [2000 – 2100].

H/W: Becomes active when the Brew Unit reach HOME or WORK position

Pres: Becomes active if the Brew Unit is present in machine

DDr: Becomes active if the Dreg Drawer is present in machine

Door: Becomes active if the Frontal Door is closed

Press **UP** (**^**): go to next page

Hydraulic Circuit

This page allow to test the functionality of hydraulic circuit:

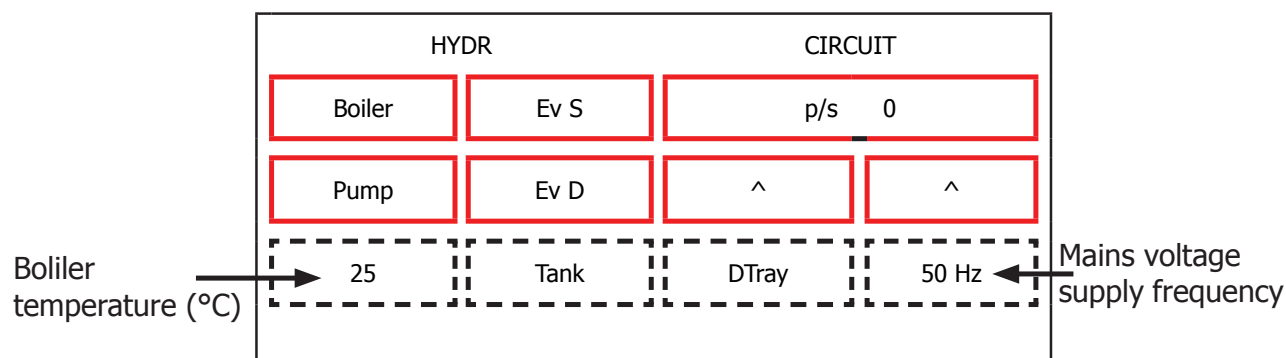

The meaning of the sectors are the following:

Command:

Boiler: when pressed activate/deactivate the boiler if the temperature is less than 90°C

Pump: when pressed activate/deactivate the pump

Ev S: when pressed activate/deactivate the Steam/Water electrovalve (24V Dc)

Ev D: when pressed activate/deactivate the discharge electrovalve (24V Dc)

Info:

p/s: indicate the current number of water flow expressed in pulses/sec. When is activated the pump and one electrovalve the value measured must be equal to or greater than 10 p/s.

Tank: Becomes active when the water into tank reach sensor level

DripTray: Becomes active when the water into drip tray reach sensor level

Frequency: indicate the frequency of mains voltage supply

Boiler Temperature: indicate the boiler temperature in °C

Press **UP** (**^**): go to next page

Grinder

This page allow to test the functionality of grinder:

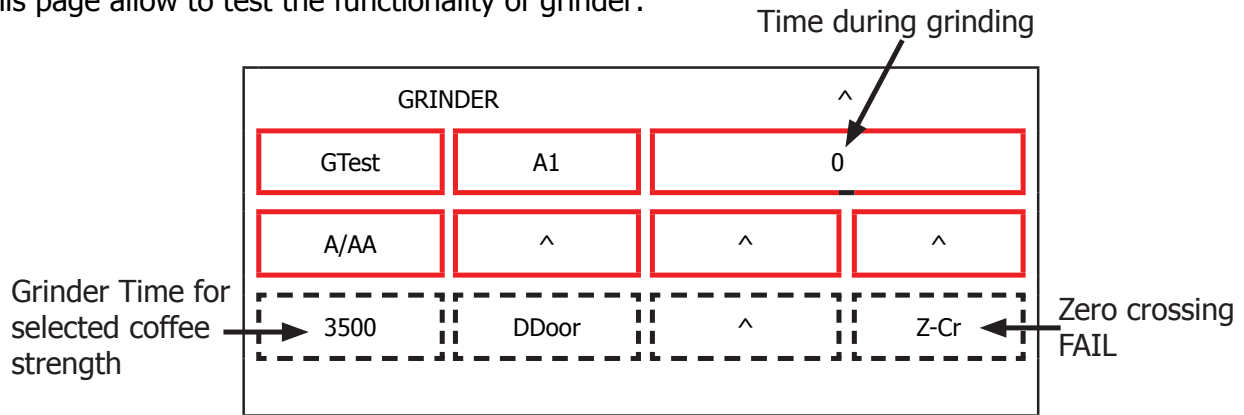

The meaning of the sectors are the following:

Command:

A1: Selected Coffee Strength. If pressed change the current coffee strength from A1 to A6

A1: Very Mild

A2: Mild

A3: Regular

A4: Strong

A5: Very Strong

A6: Extra Strong

A/AA: A = use the current coffee strength ; AA = add 33% of time to the current coffee strength

GTest: Activate/Deactivate the grinder for a time corresponding to the selected coffee strength.

Info:

Time during grinding: indicate the time while the machine is grinding in msec

DDOOR: indicate the status of hopper door (colored box -> closed)

Z-cr: Colored box indicate that the measure of zero crossing is FAIL.

Press **UP** (^): go to next page

Display

This page allow to change display settings (brightness and contrast):

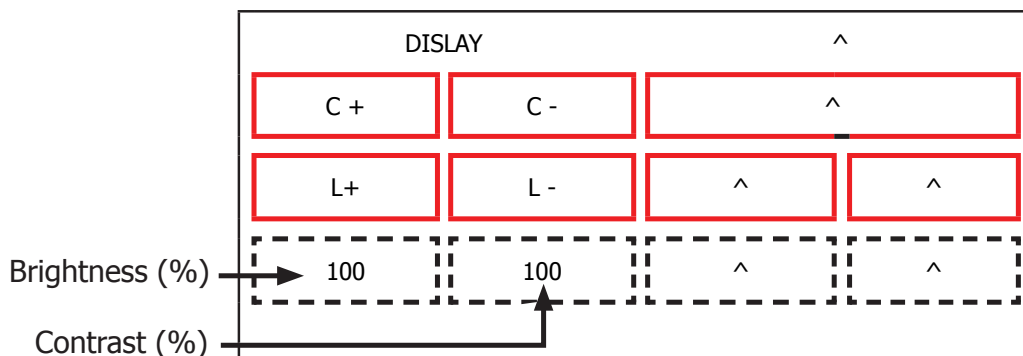

The meaning of the sectors are the following:

Command:

C+: increase the display contrast

C- : decrease the display contrast

L+: increase the display brightness

L- : decrease the display brightness

Bluetooth

This page allow to check the BT module

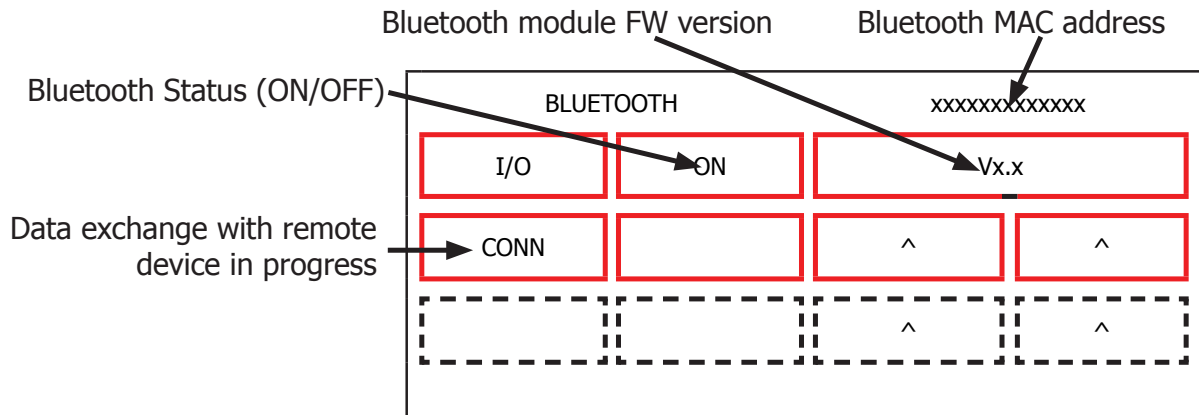

The meaning of the sectors are the following:

Command:

I/O: enable/disable Bluetooth module. Please note that switching OFF the module does not cause an alive connection to break-down. You first need to disconnect the remote device, and then the OFF status makes the CA not anymore detectable to the remote device.

Info:

ON/OFF: status of BT module (if a "-" is shown the communication is NOT OK) .

MAC Address: Mac address of the BT module (every module as a specific MAC address) (if a "-" is shown the communication is NOT OK)

BT Firmware: Firmware version of the BT module (if a "-" is shown the communication is NOT OK)

CONN: when it is lighted up, it means that a remote device is connected and exchanging information with the CA

Press **UP** (**^**): go to next page

Steam Out

This page allow to execute the steam out process:

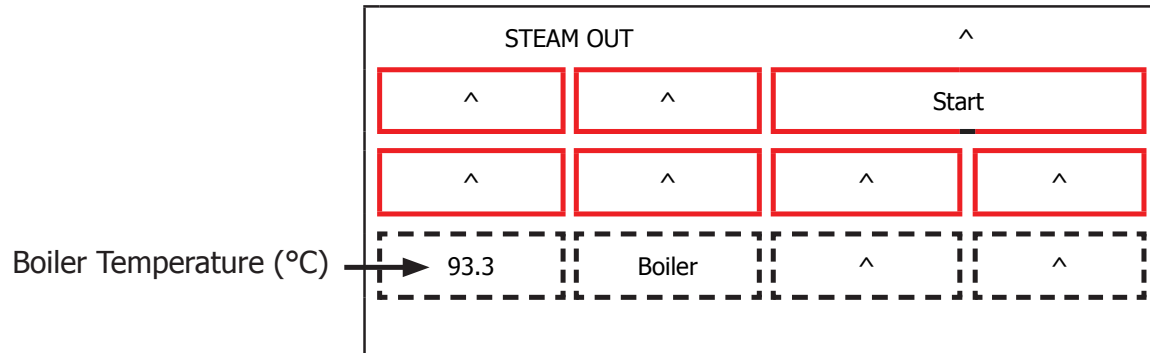

The meaning of the sectors are the following:

Command:

Start: start the steamout process. At the end of process appears: Switch Off at the bottom of the display (so it's possible to restart the machine with the default values)

Info:

Boiler: It's enabled when the boiler is activated

This is the last page of Factory Test Mode. Press **UP** to navigate to precedent page or press **DOWN** to navigate to first page. Press **ESC** to restart the machine.

5.1.2. Test Mode Gran Baristo

To enter Test Mode

When the display turns ON, press the keyboard buttons in the order described below:

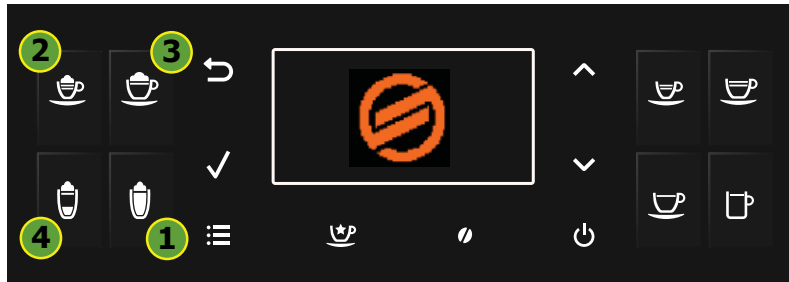

Description

When the machine is in Factory Test Mode appears a windows divided in several sectors:

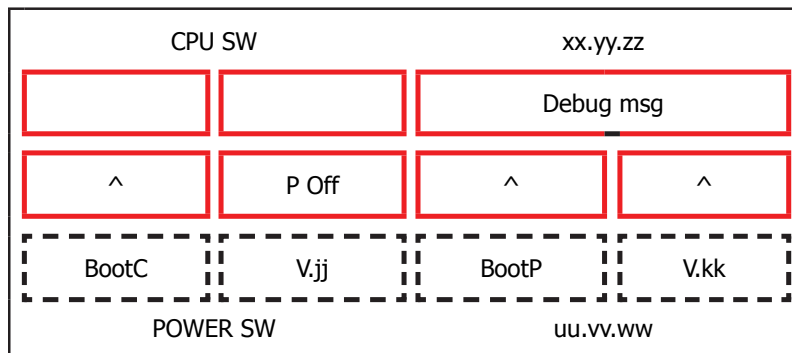

The first row of each window is a title, the red sectors represents the functions (or loads) available to activate or deactivate, the last row is used to show other info. When a function is enabled the corresponding box becomes colored. The dotted sectors is used to show informations about the status of microswitch, sensors or other variables.

The presence of symbol (^) into a sector indicate that no function is associated to.

The following image show the corrispondence between the keyboard and red sectors:

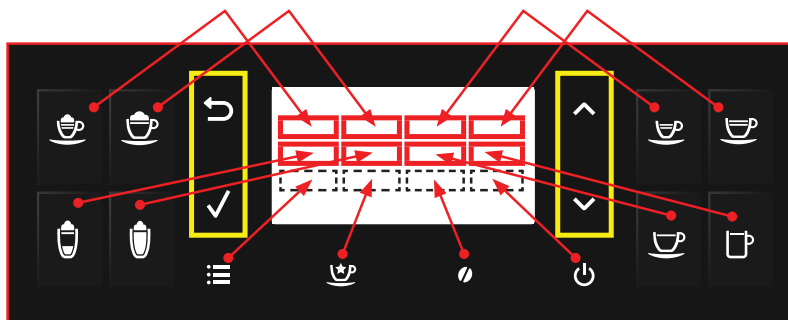

The keyboard buttons (ESC, OK, UP and DOWN), highlighted in yellow, have the following functions:

UP : go to next page

DOWN : go to previous page

OK (✓): confirm / enable / disable function

ESC (↵) : exit from Factory Test Mode

Activation of loads

In Test Mode all loads are initially disabled.

To activate a load press the corresponding button on keyboard, to deactivate press again the same button.

Other conditions for which a load may be switched off automatically without key presses are:

- If it is defined a working cycle, when this cycle ends (such as the grinder or brew unit)
- The achievement of 90°C for boiler

Navigation in Test Mode

SoftwareVersion

This is the first window of Factory Test Mode. It show the version of CPU software and CPU bootloader version, the PWR software and PWR bootloader version and is possible to activate or deactivate the POff feature and Debug info.

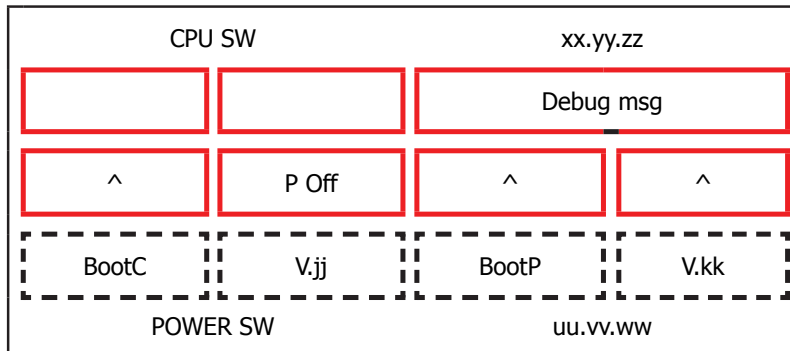

Press **OK (✓)** button to modify one of the following feature:

Debug msg: if enabled (colored box), only for next startup, allows the visualization of the following debug info on display in Ready state:

Grinder Time Aroma 1 (msec)	Encoder Pulses Home Work About Last Cycle	Encoder Dreg Counter: 4000 ->dreg drawer empty 0-> dreg drawer full	Grinder Time Aroma 4 (msec)
Grinder Time Aroma 2 (msec)			Grinder Time Aroma 5 (msec)
Grinder Time Aroma 3 (msec)			Grinder Time Aroma 6 (msec)
	Encoder Pulses HOME to Pod Pressure About Last Cycle	Target Encoder Pulses from HOME to Pod Pressure about last Cycle	

P Off: if enabled (colored box), allows the machine to enter in standby mode immediately after powering ON from the main switch.

Make sure that the function **P Off** is turned ON and the **Debug msg** is turned OFF.

Press **UP (∧)**: go to next page

Keyboard

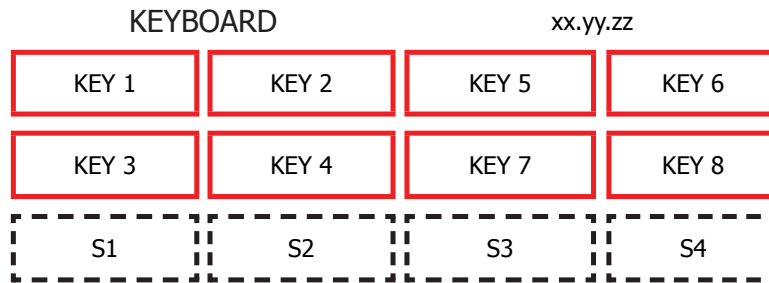

This page allow to test each button of keyboard (is shown its version) with the following correspondence:

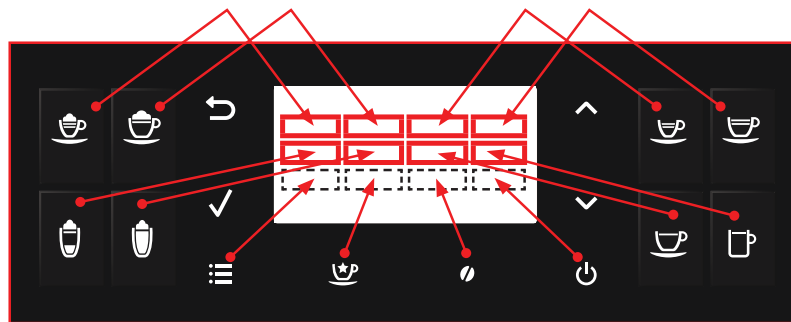

When is pressed a button the corresponding box becomes with background colored and the led of keyboard is turned ON, if it is pressed again becomes with black background and the led of keyboard is turned OFF(except for UP, DOWN and ESC that are always turned ON).

Press **UP** (^): go to next page

Brew Unit

This page allow to test the functionality of Brew Unit, BU Encoder, frontal door and dreg drawer:

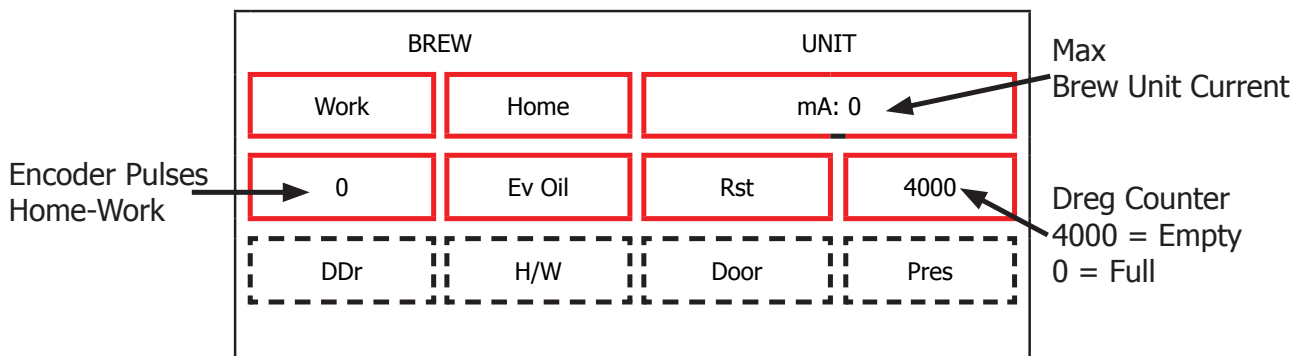

The meaning of the sectors are the following:

Command:

Work: when pressed move the brew unit to WORK

Home: when pressed move the brew unit to HOME

Ev Oil: when pressed activate/deactivate the Oil electrovalve (24V Dc)

Rst: when pressed move the brew unit in RESET(extraction) position(stop the brew unit if was in movement)

Info:

mA: indicates the maximum current (in mA) absorbed by the brew unit in motion. The value must not exceed 300 mA

Encoder Pulses Home-Work: indicate the number of encoder pulses from Home to Work position or vice versa. Move the brew unit from Home to work or vice versa and the measured value must be in the range [2000 – 2100].

H/W: Becomes active when the Brew Unit reach HOME or WORK position

Pres: Becomes active if the Brew Unit is present in machine

DDr: Becomes active if the Dreg Drawer is present in machine

Door: Becomes active if the Frontal Door is closed

Press **UP** (**^**): go to next page

Hydraulic Circuit

This page allow to test the functionality of hydraulic circuit:

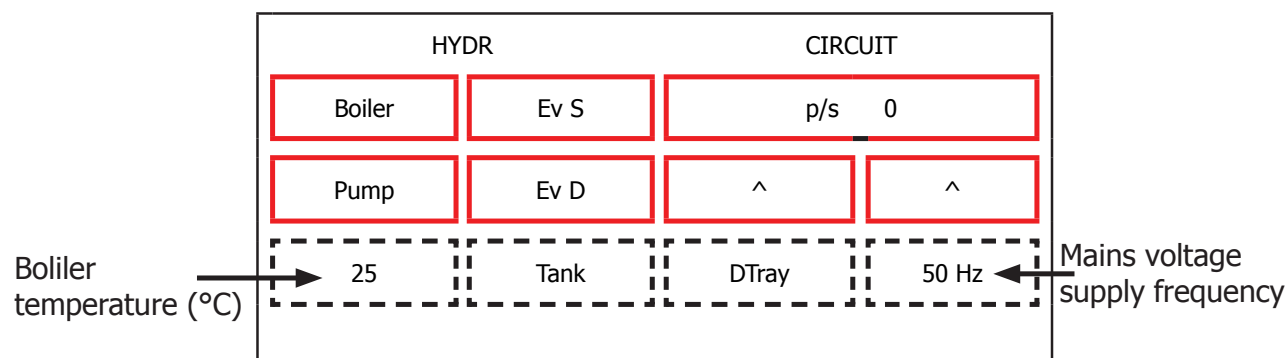

The meaning of the sectors are the following:

Command:

Boiler: when pressed activate/deactivate the boiler if the temperature is less than 90°C

Pump: when pressed activate/deactivate the pump

Ev S: when pressed activate/deactivate the Steam/Water electrovalve (24V Dc)

Ev D: when pressed activate/deactivate the discharge electrovalve (24V Dc)

Info:

p/s: indicate the current number of water flow expressed in pulses/sec. When is activated the pump and one electrovalve the value measured must be equal to or greater than 10 p/s.

Tank: Becomes active when the water into tank reach sensor level

DripTray: Becomes active when the water into drip tray reach sensor level

Frequency: indicate the frequency of mains voltage supply

Boiler Temperature: indicate the boiler temperature in °C

Press **UP** (**^**): go to next page

Grinder

This page allow to test the functionality of grinder:

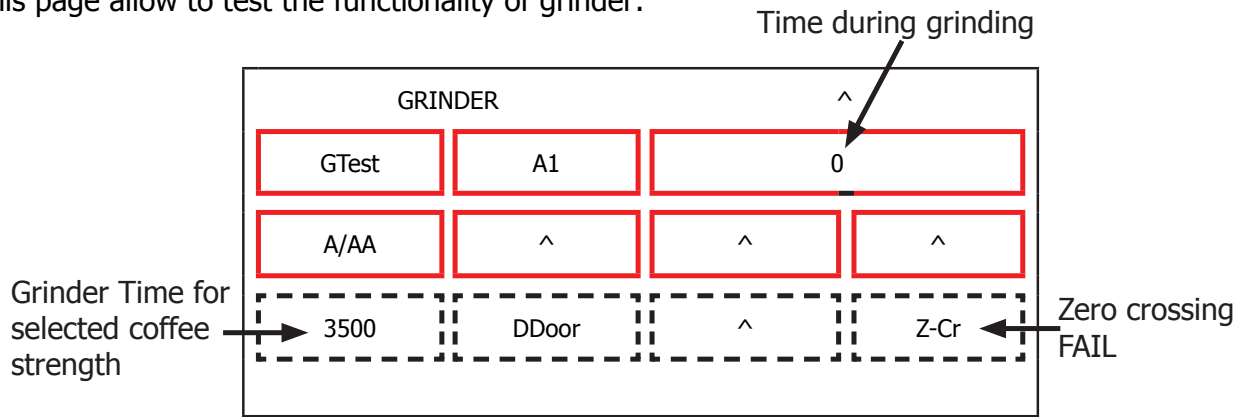

The meaning of the sectors are the following:

Command:

A1: Selected Coffee Strength. If pressed change the current coffee strength from A1 to A6

A1: Very Mild

A2: Mild

A3: Regular

A4: Strong

A5: Very Strong

A6: Extra Strong

A/AA: A = use the current coffee strength ; AA = add 33% of time to the current coffee strength

GTest: Activate/Deactivate the grinder for a time corresponding to the selected coffee strength.

Info:

Time during grinding: indicate the time while the machine is grinding in msec

DDOOR: indicate the status of hopper door (colored box -> closed)

Z-cr: Colored box indicate that the measure of zero crossing is FAIL.

Press **UP** (^): go to next page

Display

This page allow to change display settings (brightness and contrast):

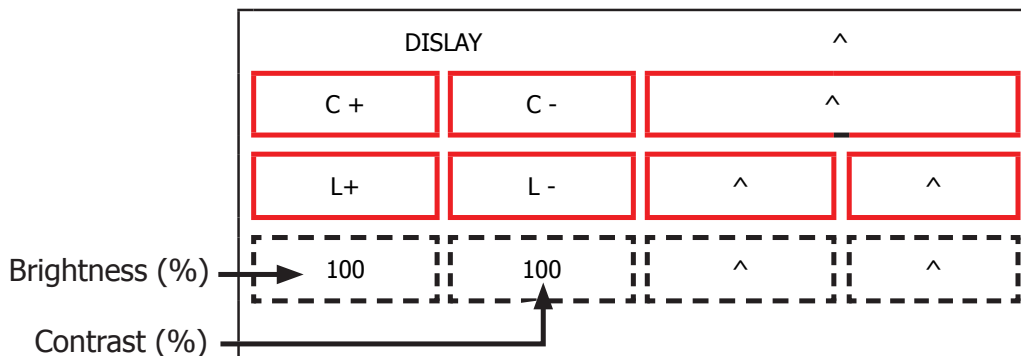

The meaning of the sectors are the following:

Command:

C+: increase the display contrast

C- : decrease the display contrast

L+: increase the display brightness

L- : decrease the display brightness

Press **UP** (^): go to next page

Steam Out

This page allow to execute the steam out process:

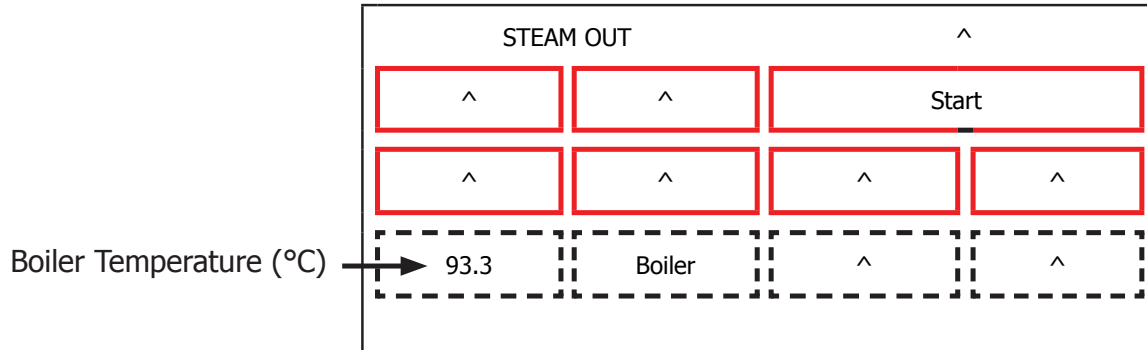

The meaning of the sectors are the following:

Command:

Start: start the steamout process. At the end of process appears: Switch Off at the bottom of the display (so it's possible to restart the machine with the default values)

Info:

Boiler: It's enabled when the boiler is activated

This is the last page of Factory Test Mode. Press **UP** to navigate to precedent page or press **DOWN** to navigate to first page. Press **ESC** to restart the machine.

5.1.3. Diagnostic Mode Gran Baristo/Gran Baristo Avanti

To enter Diagnostic Mode

When the display turns ON, press the keyboard buttons in the order described below:

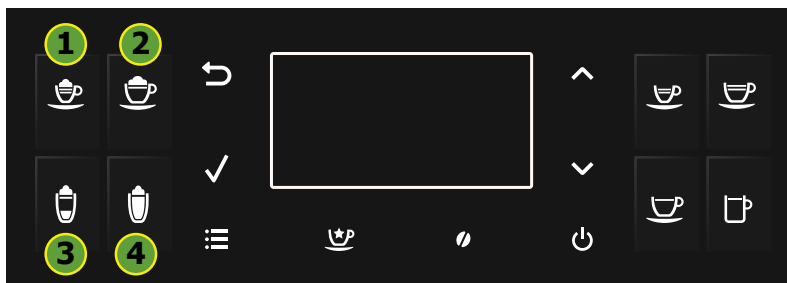

Menu Structure

DIAGNOSTIC MODE		
1. Product counters (default values 0)		Espresso
		Caffè
		Cafe Creme
		Hot water
		Cappuccino
		Latte macchiato
		Hot milk
		American Coffee
		Espresso Macchiato
		Ristretto
		Espresso Mild
		Espresso Intenso
		Energy Coffee
		Cafe Au Lait
2. Error counters (default values 0)	2.1. Errors log	Error code
		Error index
		Error text
	2.2. Errors reset	
3. Water counters (default values 0)	3.1. Descaling cycle	Liters since last
		Excess liters since last
		Liters last descale
		Excess liters last descale
		Number of execution
	3.2. Brewing unit cleaning	Number of execution
		Liters since last clean
	3.3. Since production	Liters Coffee/Water
		Liters Steam
	3.4. Water filter	Liters since last reset
		Number of reset

Detailed description of the diagnosis menu

1. Product counters

"**Product counters**" represents the total number of deliveries performed by the machine for each product from the production.

2. Error counters

"**Error counters**" displays the total number of errors "out of service" (fail) occurred in the system (see "**Errors log**"), and allows you to reset the drive (see "**Errors reset**").

The maximum number of "fail" count is 20.

The submenu "**Errors log**" is available only if there is at least one error and, if so, submit the following information:

Error code: is the numerical code for the type of fail has occurred in the system. For example, "Error code E01" is the error with index 1 and is equivalent to the Grinder blocked.

Error index: represents the numeric position of the error in the internal list.

The maximum number of elements in the list is 20: the list is handled in a circular fashion, that is, the data in the first position is always the last error that occurred in order of time (eg 01/07 means that you are reading the most recent error on a total of 7 errors).

Error text: is the text description of the type of error that occurred in the system.

For example: "**Grinder blocked.**"

The cancellation of the error list by "**Errors reset**", as it deletes all information relating thereto, also prevents access to the menu under "**Errors log**".

List of possible errors of "**out of service**":

Grinder blocked (E01): occurs if the grinder is to have the mills blocked.

In this case, the machine stops the instant the user asks for the machine to dispense a drink made of coffee (just coffee beans).

Brewing unit blocked work (E03): occurs when the brew unit can not move from location to location work home.

Brewing unit blocked home (E04): occurs when the brew unit can not move from the home position to the work position.

Water circuit interrupted (E05): occurs when the flow meter is faulty, disconnected or does not occur passage of water. In these cases, since the machine fails to correctly read the pulses of water, enters alarm condition "CHARGING CIRCUIT" in the moment in which the user asks to dispense a product:

if the "charging circuit" the machine supply fails block. This total.

DC Valve short circuit (E06): occurs when one of the valves of the flute is short-circuited. This problem may occur during the delivery of a product based on milk.

Coffee temp. sensor short circuit (E10): occurs when the temperature of the coffee boiler sensor is short-circuited. This error causes a total shutdown of the machine to start up.

Coffee temp. sensor open circuit (E11): occurs when the temperature of the coffee boiler sensor is not detected. The problem is due to the absence of the signal of the sensor and does not allow the machine to establish the actual temperature of the coffee boiler. At start up, the machine enters the halt.

Boiler coffee timeout (E14): occurs when no power coming to the coffee boiler, this does not reach the preset temperature within a time of 2 minutes.

At start up the machine remains long in the screen WAITING READY TEMPERATURE, with the message "Warming up ...", and after the expiry of the time goes to lock out.

Zero crossing error (E19): occurs when the machine does not detect the signal zero crossing.

Coffee boiler overheating (E20): occurs when the temperature of the coffee boiler and exceeds 170 ° C.

BU encoder error (E24): occurs when the machine is not correctly detect the signal of the encoder

3. Water counters

"Water counters" shows water consumption (in liters) following delivery of products, the descaling cycle, the cleaning cycle the activation group and filter.

The submenu "Descaling cycle" has the following items:

Liters since last: represents the total number of gallons of water consumed since the last descaling cycle. It is reset after the complete execution of the descaling cycle.

Excess liters since last: represents the number of liters of water consumed in excess since the car signals the descaling indicator.

It is reset after the complete execution of the descaling cycle.

Liters last descale: represents the total number of gallons of water consumed until the last descaling cycle.

Takes the value of "Liters since last" after the complete execution of the descaling cycle.

Excess liters last descale: represents the number of liters of water consumed in excess since the car reported the descaling indicator until the last descaling cycle.

Takes the value of "Excess liters since last" after the complete execution of the descaling cycle.

Number of execution: represents the number of cycles executed on the machine descaling.

The sub-menu **"Brewing unit cleaning"** has the following items:

Number of execution: represents the number of cleaning cycles performed on the machine group.

Liters since last clean: represents the total number of gallons of water consumed since the last cleaning cycle group. It is reset after the execution of a complete cleaning cycle group

The submenu "**Water filter**" has the following items:

Since last reset: represents the total number of gallons of water from the last cycle of activation filter.

It is reset after the execution of the cycle of activation filter.

Number of reset: represents the number of cycles performed activation filter on the machine

The item "**Since production**" has the following items:

Liters Coffee / Water represents the total number of liters of water consumed during the execution of coffee products (or the mixed coffee) or water.

Liters Steam represents the total number of liters of water consumed during the execution of milk products (milk or mixed part).

4. Grinding auto dose

The submenu "**Grinding timer**" indicates for each flavor (Dose 1 Dose ... 6) the grinding time in msec.

These values evolve over time depending on the technique of 'autodose'.

The submenu "**Encoding strength**" indicates the multiplicative constants used to calculate the expected volume of each flavor (multiplicative constant * gr = number of encoder pulses relative to the volume of the aroma: es: aroma 1 -> $44 * 5 = 220$).

The submenu "**Bean lack alarm**" indicates for each flavor the minimum number of encoder pulses (volume of the pad) that allows you to not give the alarm without coffee.

The submenu "Dregdrawer alarm" has the following items:

"Dreg alarm": indicates the value at which the counter is reset funds to indicate the alarm funds.

"Dreg counter" represents funds that the counter is initialized to the value of "Dreg alarm" to any empty the drawer bottoms and decremented by a value depending on the dose in the ground made products. When is 0 the machine will display the alarm drain funds.

5.2. Error codes

ERROR CODES	DESCRIPTION
01	Grinder blocked
03	Brewing UNIT blocked work
04	Brewing UNIT blocked home
05	Water circuit interrupted
06	DC valve short circuit
10	Coffee temp. sensor short circuit
11	Coffee temp. sensor open circuit
14	Boiler coffee timeout
19	Zero crossing error
20	Boiler coffee overheating
24	BU Encoder Error



CHAPTER 6

STANDARD CHECKS

6.1. Repair schedule

	Action
1	Visual inspection (transport damage)
2	Machine data check (rating plate)
3	Operational check / problem analysis
4	Opening machine
5	Visual inspection
6	Operational tests
7	Repairing the faults encountered
8	Checking any modifications (view Symptom Cure, new software, etc.)
9	Service activities in accordance with the operating schedule
10	Internal cleaning
11	Operational test while the appliance is open
12	Assembly
13	Final inspection test
14	Draining the circuit (in winter)
15	External cleaning
16	Lubricating the brewing unit with suitable grease
17	Insulation test HG 701 (dielectric)
18	Documentation

6.2. Service schedule

S Replacement

ES Visual inspection

D Descaling

P Cleaning

R Adjustment

Component	Action	Support/tool
Water filter	P/ES	
Water tank lip seal	ES	
Boiler pin O-ring	ES	
Brewing unit	ES/P	Grease solvent / Grease
Hoses, attachments and Oetiker clamps	ES	
Coffee grinder	P/R	Vacuum cleaner / brush
Water circuit	D	Saeco descaler
Hot water/steam valve	ES	

6.3. Final test

Test	Procedure	Support/ tool	Standard	Tolerance
Espresso	2-3 Espressos for adjustment purposes	Measuring scoop	Same amount	15%
Coffee	2-3 Coffees for adjustment purposes	Measuring scoop	Same amount	15%
Noise			Standard	
Amount of cream	Blow into the cup until the cream separates		The cream should come together again to form a complete layer	
Cream colour			Hazel brown	
Temperature	Reading taken while dispensing	Thermometer	84 °C	± 4 °C
Grinding level	Check the grain size of the ground coffee			
Hot water	Dispense water			
Steam	Dispense steam			
Dreg drawer missing indication	Remove the dreg drawer		Dreg drawer missing indication	
Low bean level indication	Start brewing a coffee while the coffee bean hopper is empty		Low bean level indication	



CHAPTER 7

DISASSEMBLY

7.1. Outer Shell

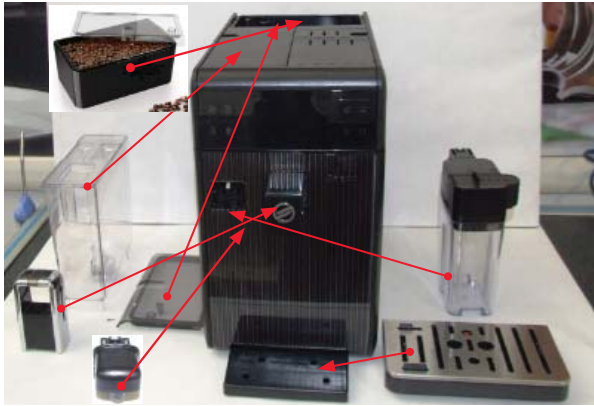

Remove the water tank, coffee container and cover, drip tray, dreg drawer, brewing unit, hot water dispenser, Milk carafe.

Lateral panels



Unscrew the screws shown.



Remove the cover.



Unscrew the screw shown.

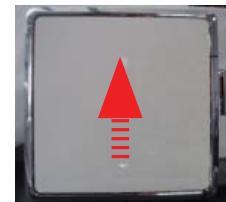

Remove the left, right and posterior panels

Top cover



CAUTION: Every time that it's necessary to access inside the machine, after removing of the two lateral panel, the capacitive keyboard must be fixed on the appliance side with paper adhesive tape, as shown in the image.

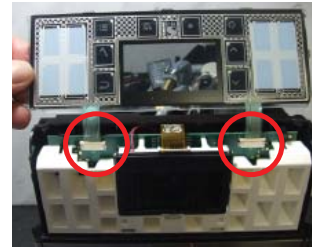

This action serves to avoid damaging the electrical connections.

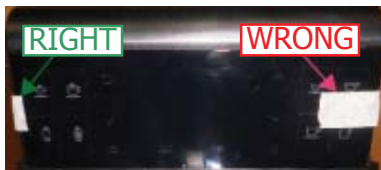

Take care to not cover keyboard buttons with the tape.



Unscrew the screw shown.

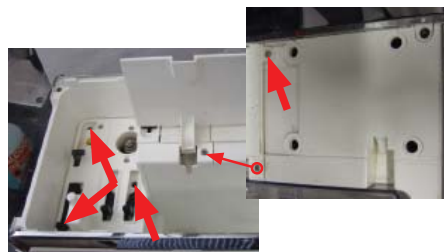

Unscrew the screws shown.

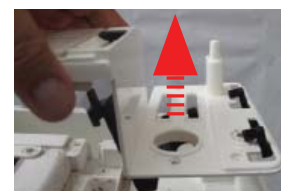

Remove the cover.



Remove the reed sensor.



Disconnect all electrical and water circuit connections and remove the top cover.

7.2. Service door



Unscrew the screws shown.



Remove the high-lighted frame.



Lift the pin with a screwdriver and remove it through the top of the door.



Graft milk carafe and hot water



Unscrew the screws indicated and remove the cover.



Unscrew the screws indicated.

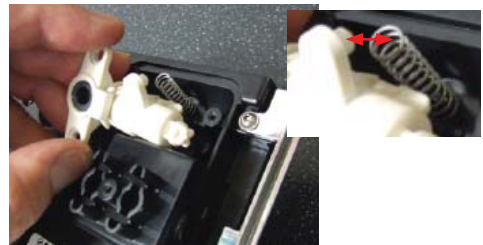

In the reassembling make sure the spring is repositioned correctly (see photo).

Dispenser assembly



Unscrew the screws indicated.



To remove the cover slide downwards and after to the right to release the anchors "see images".





Remove the dispenser, remove the insert and unhook the anchors.

7.3. Coffee grinder



Remove the cover.

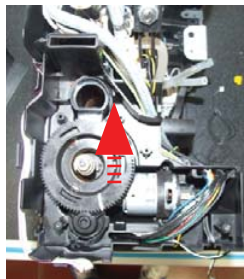

Raise the coffee grinder and remove the connections.

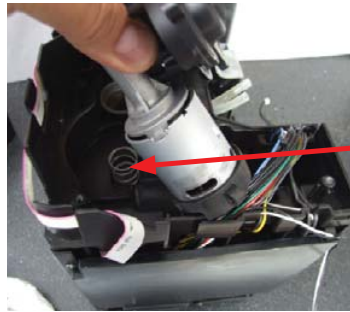

When reassembling the coffee grinder, make sure the spring is repositioned correctly (see photo).

7.4. Grinder blades

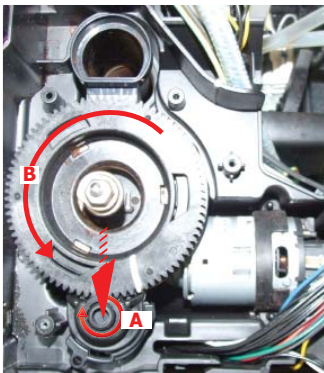

To extract the top support of the appliance, press on the grinding adjustment spindle (A) and turn the support anticlockwise until it unhooks.



Turn the grinder blades anticlockwise out of the support.

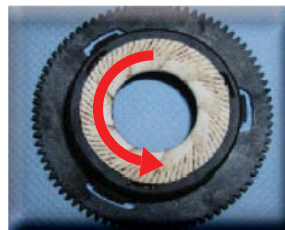

Turn the grinder blades clockwise out of the support. The bayonet connections can be accessed from the rear.

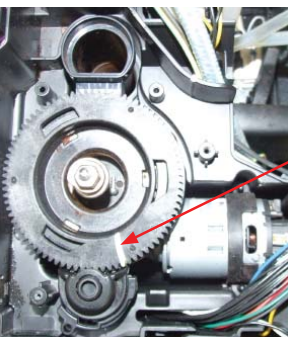

For a standard adjustment, both markings must be aligned.

7.5. Coffee grinder adjustment

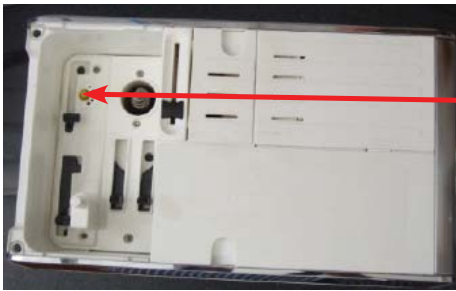

The grinding adjustment can be set by the user (only with the coffee grinder in operation) by pressing and turning (only by one click at a time) the insert inside the coffee bean hopper with the aid of the wrench supplied.

Adjustment by a service center

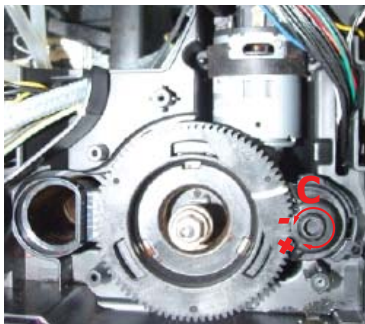

To adjust grinding further, the technical service can work directly on the coffee grinder by pressing and turning the ring nut (C) shown. (clockwise + to increase the particle size of the coffee and anticlockwise - to decrease it).

If there are any remains of coffee powder between the two grinding blades it is recommended to tighten by max. two marks at a time.

Lastly, move the point yellow (A) on the adjustment knob to the center of the adjustment .

7.6. Solenoid valve and assembly drain valve



Loosen the screws holding the solenoid valve to the upper plate

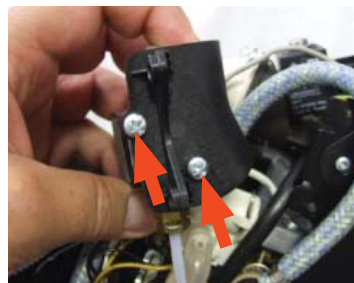

Loosen the screws holding in the support the solenoid valve.



Disconnect all electrical and water circuit connections.

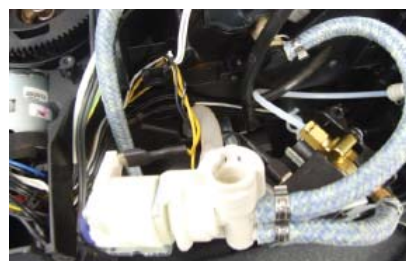

Slide out the fork as illustrated and disconnect the electrical / idraulics connections.

7.7. The piston assembly.

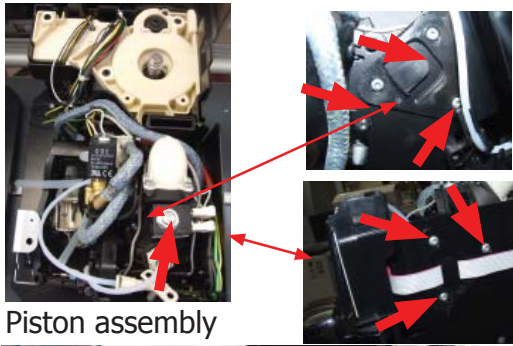

Piston assembly

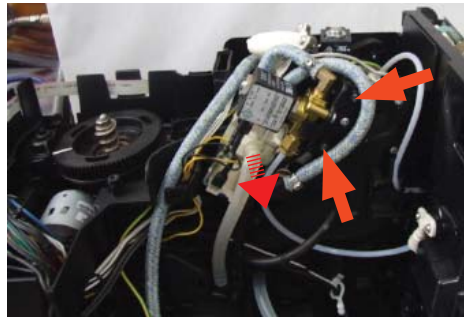

Loosen the screws highlighted and disconnect the silicone tube.



Remove the assembly and disconnect the electrical / idraulics connections.

7.8. Pin boiler



Loosen the screws highlighted and slide out the fork as illustrated.

7.9. Thermostats

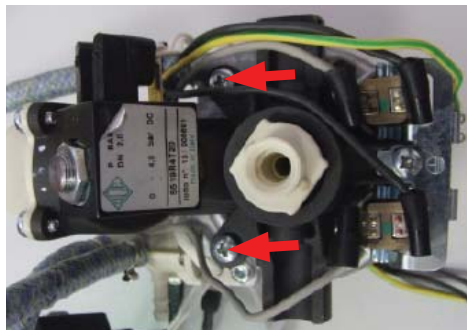

CAUTION: Do not unscrew the screws highlighted for no reason.



Loosen the screws highlighted and remove the thermostats unplugging from the electrical connections.



7.10. Pump

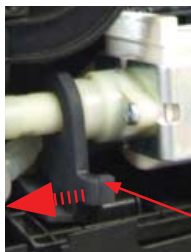

Slip off the pump off the support.

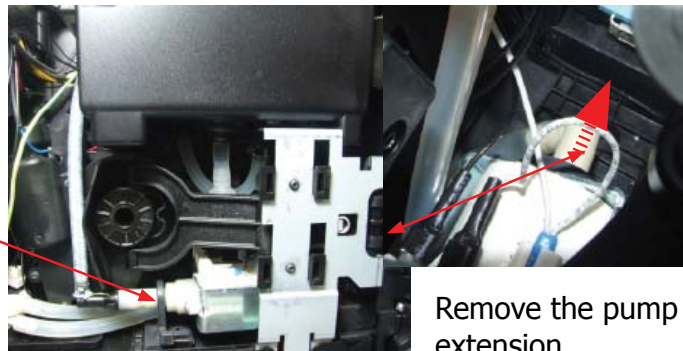

Remove the pump extension.



Disconnect the electrical / idraulics connections.

7.11. Flow-meter

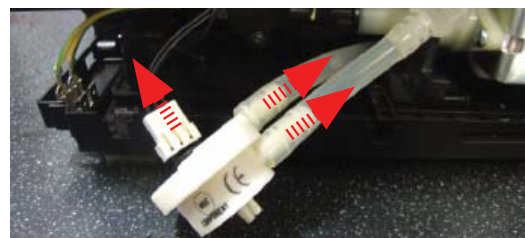
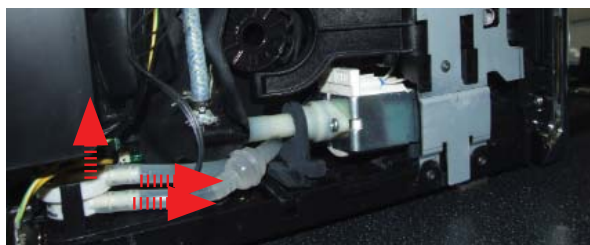

Lift the flow meter out of the casing assembly and remove the electrical and water circuit connections.

7.12. Gearmotor and microswitch present brew unit.

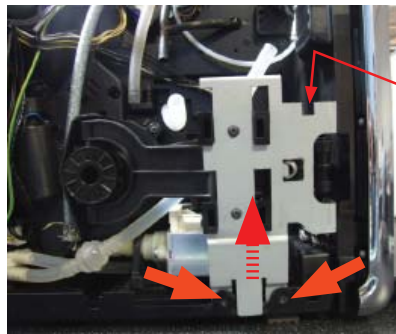

Loosen the screws, unlock the pin and remove the system of levers.



In the reassembling make sure the spring is repositioned correctly (see photo).

Microswitch present brew unit.

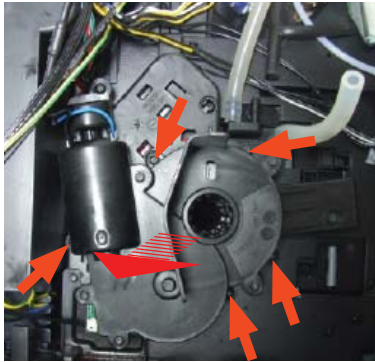

Loosen the screws highlighted and remove the gearmotor assembly.



Lift the assembly and in the back there is the microswitch.

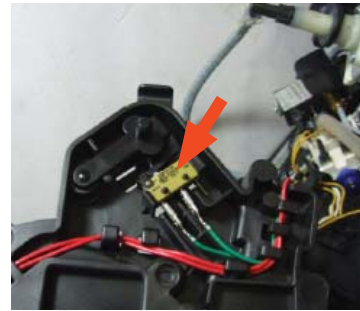

Loosen the screws highlighted and remove the gearmotor cover.

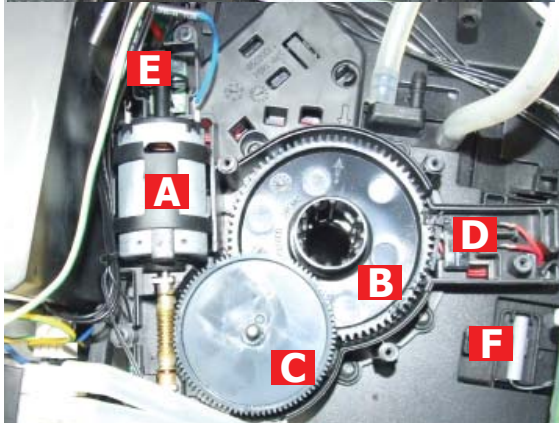

The following are located inside the compartment protected by the casing:

- Electric motor (A) with gears (B) and (C) for transmission and timing of the dispenser.
- Microswitch (D) detecting brewing unit home and work positions.
- Remove the gear (C) that meshes with the motor transmission shaft.
- Remove the large gear (B).
- Remove the motor (A), complete with transmission shaft.
- Gear box encoder board (E)
- Drip tray sensor reed (F)

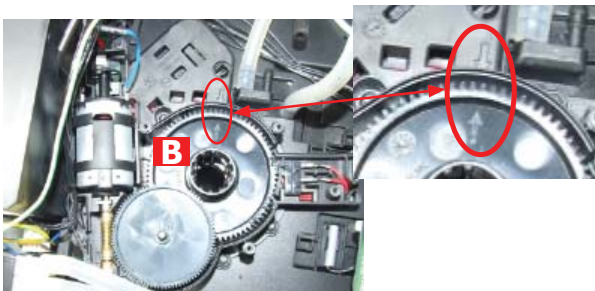

Replace the gear (B), making sure that the imprint of the arrows are aligned.

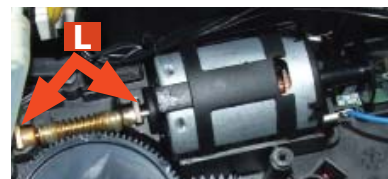

When replacing the motor and the transmission shaft, make sure the guide runners (L) are in the right position.
Grease the shaft thoroughly and evenly.

7.13. CPU board and KYB interface and display

Lateral panels

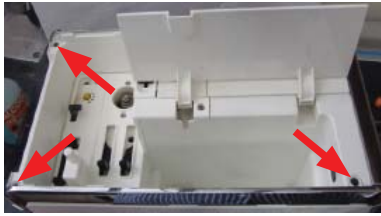

Unscrew the screws shown.



Remove the cover.



Unscrew the screw shown.

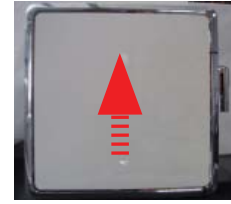

Remove the left, right and posterior panels

Top cover



Unscrew the screw shown.

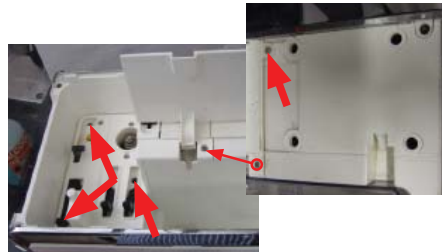

Unscrew the screws shown.

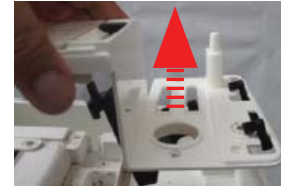

Remove the cover.



Remove the reed sensor.



Disconnect all electrical and water circuit connections and remove the top cover.

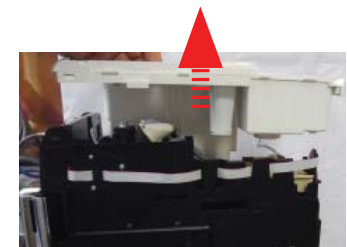

CPU board



Remove the cover.

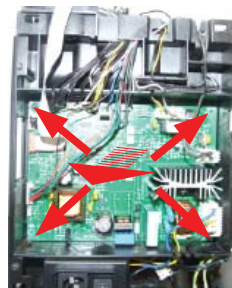

Unscrew the screws and extract the card off the support and disconnect the electrical connections.

KYB interface and display

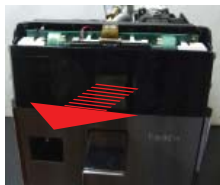

Remove the KYB interface and display.



Remove the electrical connections.



Disconnect the electrical connections.

7.14. Bluetooth board in Granbaristo Avanti

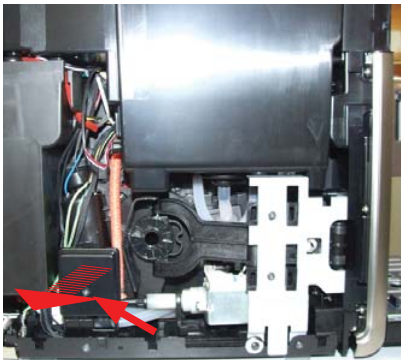

Unscrew the screw shown and remove the cover.

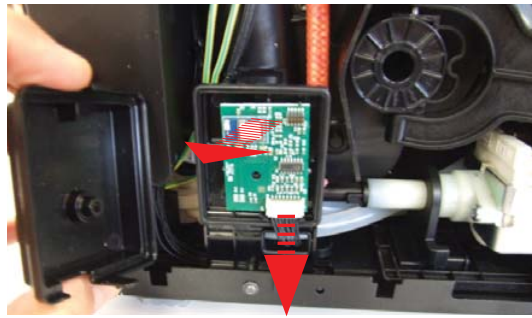

Disconnect the electrical connections and remove the bluetooth board.

7.15. Fitting and removing Oetiker clamps

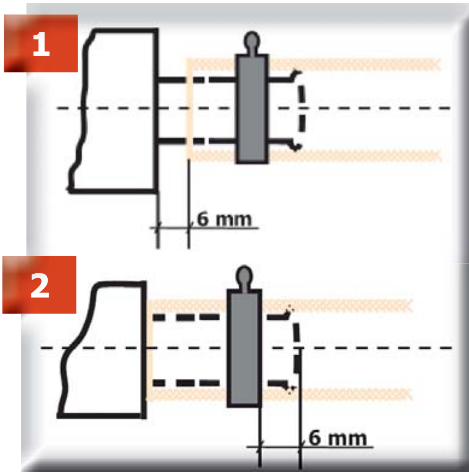

1) Boiler connection.

2) Other connections.

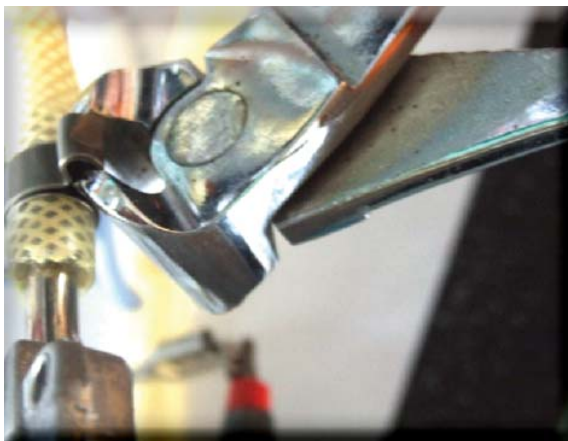

Use a suitable pair of pliers to remove the clamp (as illustrated).



Tighten the clamp as illustrated.



CHAPTER 8

NOTES



CHAPTER 9

WATER CIRCUIT DIAGRAM

Gran Baristo

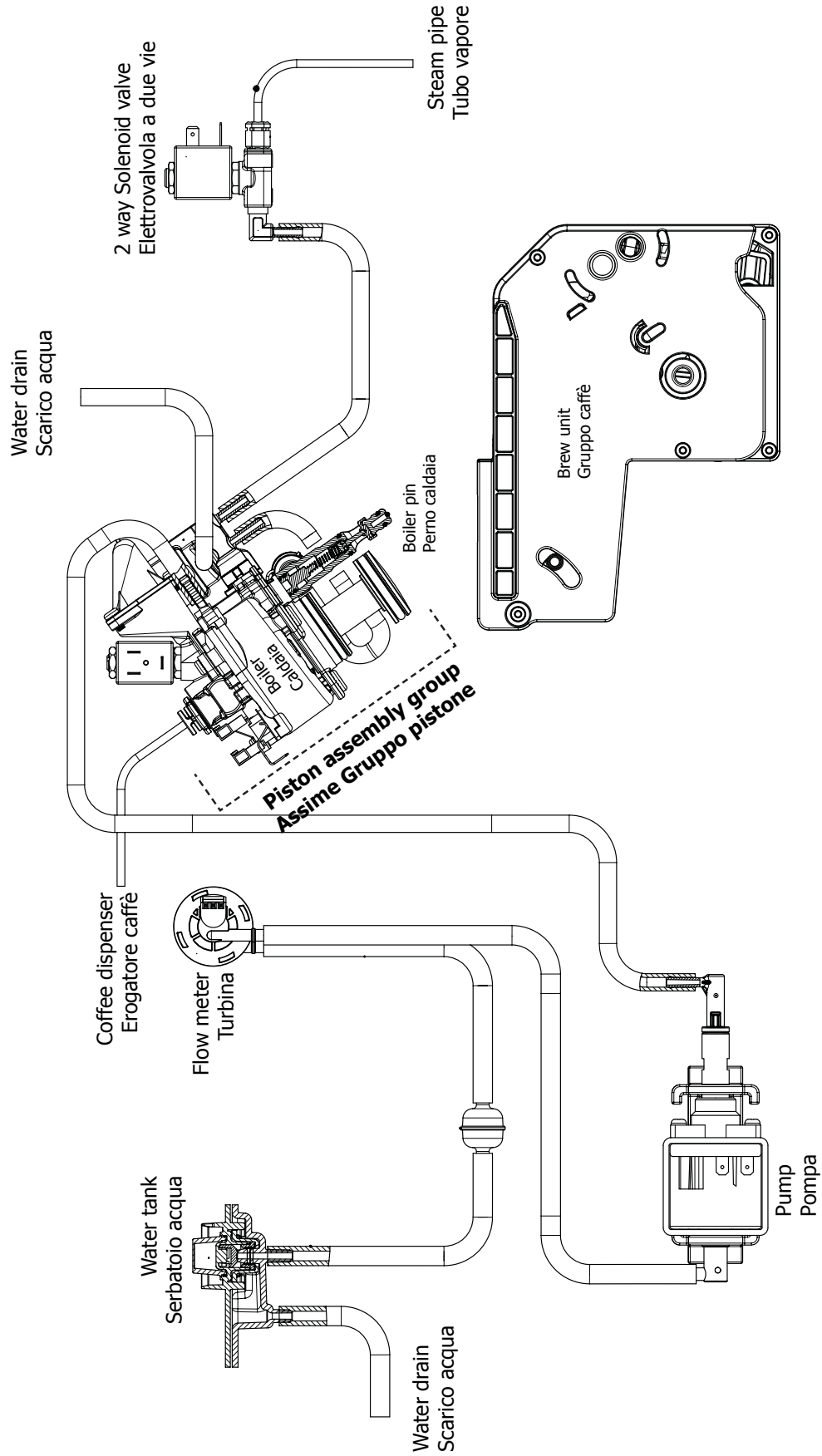



CHAPTER 10

ELECTRICAL DIAGRAM

Gran Baristo Avanti

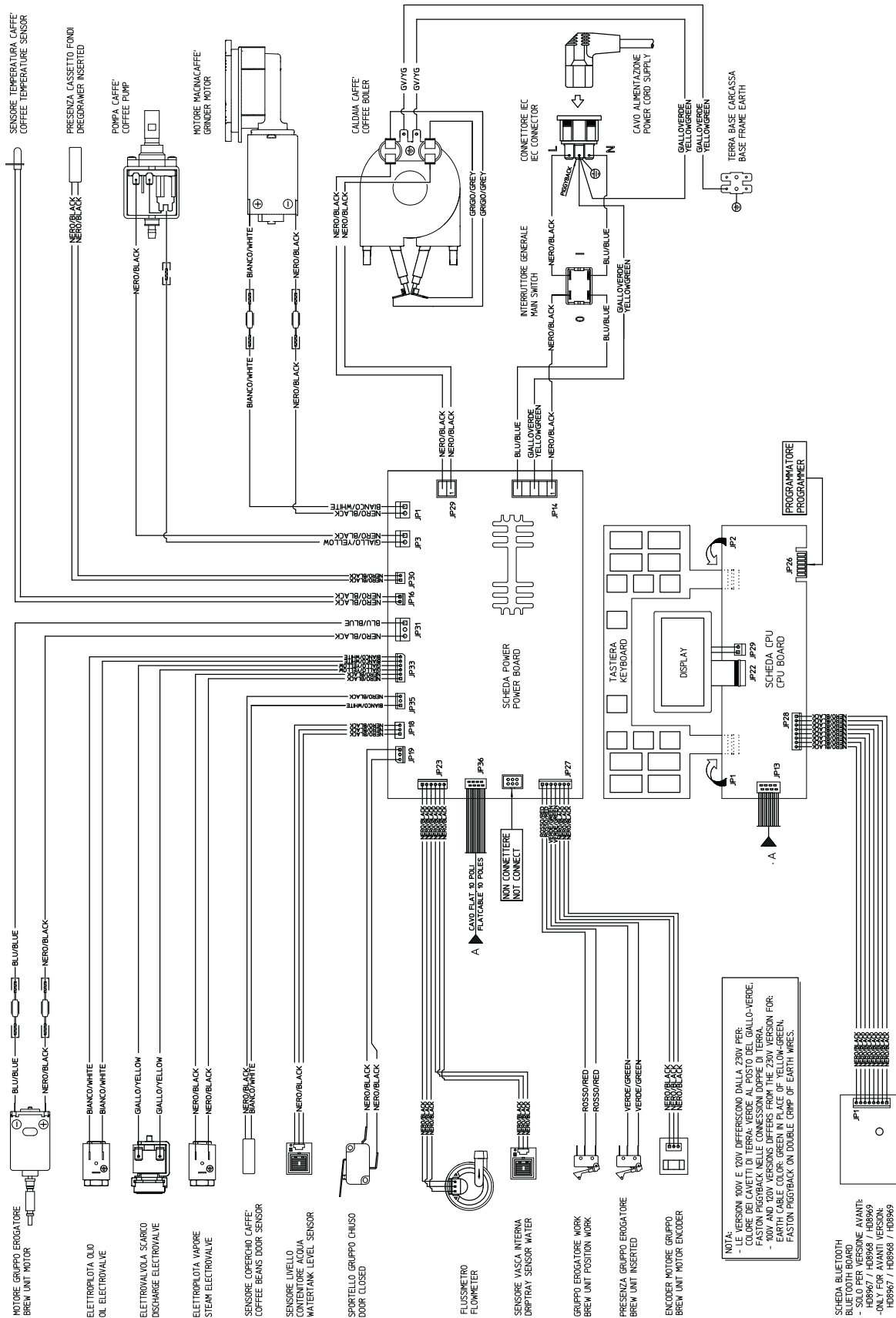

Gran Baristo

